



Dump Trailer
Owner's Manual
Gooseneck Trailers

WARNING
This Owner's Manual contains safety information and instructions for your trailer.
You must read this manual before loading or towing your trailer.
You must follow all safety precautions and instructions.

February 2025

U-Dump Trailers, LLC
2656 N.W. 10th Street
Ocala, FL 34475

Contents

1. INTRODUCTION..... 5
2. SAFETY ..... 6
2.1 Safety Alert Symbols And Signal Words ..... 6
2.2 Major Hazards ..... 6
2.2.1 IMPROPER SIZING OF TRAILER TO TOW VEHICLE ..... 6
2.2.2 DRIVING TOO FAST ..... 6
2.2.3 ADJUST DRIVING WHEN TOWING TRAILER ..... 7
2.2.4 TRAILER NOT PROPERLY COUPLED TO HITCH..... 7
2.2.5 PROPER USE OF SAFETY CHAINS ..... 8
2.2.6 PROPER CONNECTION OF BREAKAWAY BRAKE..... 8
2.2.7 MATCHING TRAILER AND HITCH ..... 8
2.2.8 WORN TIRES, LOOSE WHEELS AND LUG NUTS ..... 8
2.2.9 IMPROPER LOADING ..... 9
2.2.10 UNSAFE LOAD DISTRIBUTION ..... 10
2.2.11 SHIFTING CARGO ..... 10
2.2.12 INAPPROPRIATE CARGO ..... 11
2.2.13 INOPERABLE BRAKES OR LIGHTS ..... 11
2.2.14 TRAILER MODIFICATIONS..... 11
2.2.15 DUMP TRAILER HAZARDS ..... 11
2.2.16 TRAILER TOWING GUIDE..... 12
2.2.17 SAFE TRAILER TOWING GUIDELINES ..... 13
2.2.18 SAFETY WARNING LABELS ON YOUR TRAILER ..... 14
2.2.19 REPORTING SAFETY DEFECTS ..... 15
3. TIRE SAFETY INFORMATION..... 16
3.1 Trailer Tire Information..... 16
3.2 Steps For Determining Correct Load Limit - Trailer ..... 17
3.2.1 TRAILERS 10,000 POUNDS GVWR OR LESS ..... 17
3.2.2 TRAILERS OVER 10,000 POUNDS GVWR ..... 17
3.3 Steps For Determining Correct Load Limit - Tow Vehicle..... 18
3.4 Glossary Of Tire Terminology..... 18
3.5 Tire Safety - Everything Rides On It..... 20
3.5.1 SAFETY FIRST- BASIC TIRE MAINTENANCE ..... 21
3.5.2 FINDING YOUR VEHICLE'S RECOMMENDED TIRE PRESSURE AND LOAD LIMITS ..... 21
3.5.3 UNDERSTANDING TIRE PRESSURE AND LOAD LIMITS ..... 21
3.5.4 SAFETY FIRST- BASIC TIRE MAINTENANCE ..... 21
3.5.5 STEPS FOR MAINTAINING PROPER TIRE PRESSURE ..... 21
3.5.6 TIRE SIZE..... 22
3.5.7 TIRE TREAD ..... 22
3.5.8 TIRE BALANCE AND WHEEL ALIGNMENT..... 22
3.5.9 TIRE REPAIR ..... 22
3.5.10 TIRE FUNDAMENTALS ..... 22
3.5.10.1 INFORMATION ON PASSENGER VEHICLE TIRES ..... 22
3.5.10.2 UTQGS Information ..... 23
3.5.10.3 Additional Information On Light Truck Tires ..... 23
3.5.10.4 Tire Safety Tips..... 24

Contents

<b>4. COUPLING TO TOW VEHICLE</b> .....	<b>25</b>
4.1 Tow Vehicle And Hitch.....	25
4.1.1 TRAILER INFORMATION .....	25
4.1.2 TOW VEHICLE.....	25
4.2 Coupling And Uncoupling The Trailer .....	25
4.3 Couple Trailer To Tow Vehicle .....	26
4.3.1 TRAILER WITH BALL RECEIVER.....	26
4.3.1.1 BEFORE COUPLING TRAILER TO TOW VEHICLE .....	27
4.3.1.2 PREPARE RECEIVER AND BALL.....	27
4.3.1.3 COUPLE TRAILER TO TOW VEHICLE .....	27
4.3.1.4 CONNECT SAFETY CHAINS .....	28
4.3.1.5 CONNECT ELECTRICAL CABLE .....	28
4.3.1.6 ATTACH BREAKAWAY BRAKE LANYARD .....	28
4.3.1.7 TEST ELECTRIC BRAKES .....	29
4.3.1.8 TEST ELECTRIC BREAKAWAY BRAKES .....	29
4.3.1.9 UNCOUPLE TRAILER WITH BALL RECEIVER.....	30
4.3.2 TRAILER WITH KING PIN .....	30
4.3.2.1 BEFORE COUPLING TRAILER TO TOW VEHICLE .....	30
4.3.2.2 PREPARE KING PIN AND FIFTH WHEEL.....	31
4.3.2.3 COUPLE TRAILER TO TOW VEHICLE .....	31
4.3.2.4 CONNECT ELECTRICAL CABLE .....	32
4.3.2.5 ATTACH BREAKAWAY BRAKE LANYARD .....	32
4.3.2.6 TEST ELECTRIC BRAKES .....	33
4.3.2.7 TEST ELECTRIC BREAKAWAY BRAKES .....	33
4.3.2.8 UNCOUPLE TRAILER WITH KING PIN .....	34
4.4 Tongue Weight .....	34
4.5.1 CHECKING TONGUE WEIGHT.....	34
4.5 Adjust Gooseneck Height .....	35
<b>5. LOADING AND UNLOADING</b> .....	<b>36</b>
5.1 Dump Trailer Hazards .....	36
5.2 Loading Fixed Loads .....	37
5.2.1 REAR LOADING EQUIPMENT .....	37
5.2.2 SIDE LOADING PALLETIZED MATERIAL .....	38
5.3 Loading And Unloading Bulk Material .....	38
5.3.1 PREPARE TRAILER FOR LOADING.....	38
5.3.2 LOADING BULK MATERIAL .....	38
5.3.3 UNLOAD BULK MATERIAL WITH SPREADER GATE.....	39
5.3.4 UNLOAD BULK MATERIAL WITH SWING GATES .....	41
5.4 Hydraulic Components .....	41
5.5 Body Prop.....	42
5.6 Securing Cargo.....	44

<b>6. PRE-TOW CHECKLIST</b> .....	<b>44</b>
6.1 Pre-Tow Checklist.....	44
6.2 Make Regular Stops .....	44
<b>7. BREAKING IN A NEW TRAILER</b> .....	<b>45</b>
7.1 Retighten Lugs At First 10, 25 & 50 Miles.....	45
7.2 Adjust Brakes At First 200 Miles .....	45
7.3 Synchronizing Brake Systems .....	45
<b>8. ACCESSORIES</b> .....	<b>46</b>
8.1 Accessory Battery .....	46
<b>9. INSPECTION, SERVICE AND MAINTENANCE</b> .....	<b>47</b>
9.1 Inspection, Service & Maintenance Summary Charts .....	47
9.2 Inspection And Service Instructions.....	50
9.2.1 TRAILER STRUCTURE.....	50
9.2.1.1 FASTENERS AND FRAME MEMBERS .....	50
9.2.1.2 WELDS.....	50
9.2.2 TRAILER BRAKES - ELECTRIC.....	50
9.2.2.1 BRAKE DISCS, SHOES AND DRUMS .....	50
9.2.2.2 MANUALLY ADJUSTING BRAKE SHOES.....	51
9.2.2.3 ELECTRIC BRAKES .....	51
9.2.2.4 TOW VEHICLE OPERATED ELECTRIC BRAKES .....	51
9.2.2.5 ELECTRIC BRAKE MAGNETS.....	51
9.2.3 TRAILER BRAKES - HYDRAULIC (IF EQUIPPED) .....	51
9.2.4 TRAILER CONNECTION TO TOW VEHICLE .....	52
9.2.4.1 GOOSENECK RECEIVER AND BALL .....	52
9.2.4.2 KING PIN AND FIFTH WHEEL.....	52
9.2.5 LANDING LEG OR JACK .....	52
9.2.6 LIGHTS AND SIGNALS .....	52
9.2.7 WHEEL RIMS.....	52
9.2.8 WHEEL BEARINGS .....	52
9.2.9 TIRES .....	52
9.2.10 LUBRICATION .....	53
9.2.11 HYDRAULIC RESERVOIR.....	54
9.2.12 LUG NUTS .....	54

## Introduction

### 1. INTRODUCTION

Congratulations on the purchase of your trailer. We believe you will be happy and completely satisfied with your purchase. Our goal is to provide a valued customer a quality trailer at a reasonable price.

For your safety, read and understand this manual before operating your trailer. If there are any questions about information in this manual, please consult your dealer.

When calling about your trailer, please have the VIN number available for the dealer. The VIN number is normally on the front left side of the trailer.

For future reference, please write your VIN number in the space below:

This manual covers the basic trailer. You must read, understand and follow the instructions given by the trailer manufacturer, tow vehicle and trailer hitch manufacturers. Keep all manuals provided with your trailer in a safe place at all times.

Inserts providing information on axles and tire warranty are provided with this manual. Please keep these inserts for future reference.

## Safety

### 2. SAFETY

#### 2.1 SAFETY ALERT SYMBOLS AND SIGNAL WORDS

An Owner's Manual that provides general trailer information cannot cover all of the specific details necessary for the proper combination of every trailer, tow vehicle and hitch. You must read, understand and follow the instructions given by the tow vehicle and trailer hitch manufacturers, as well as the instructions in this manual.

Our trailers are built with components produced by various manufacturers. Some of these items have separate instruction manuals. Where this manual indicates that you should read another manual, and you do not have that manual, contact your dealer for assistance.

The safety information in this manual is denoted by the safety alert symbol:



This symbol means ATTENTION! BECOME ALERT! YOUR SAFETY IS INVOLVED!

The level of risk is indicated by the following signal words:

**⚠ DANGER**  
DANGER - Indicates a hazardous situation, which, if not avoided, WILL result in death or serious injury.

**⚠ WARNING**  
WARNING - Indicates a hazardous situation, which, if not avoided, could result in death or serious injury.

**⚠ CAUTION**  
CAUTION - Indicates a hazardous situation, which, if not avoided, could result in minor or moderate injury.

**NOTICE**  
NOTICE - Indicates a situation that could result in damage to the equipment or other property.

#### 2.2 MAJOR HAZARDS

Loss of control of the trailer or trailer/tow vehicle combination can result in death or serious injury. The most common causes for loss of control of the trailer are:

- Improper sizing the trailer for the tow vehicle, or vice versa.
- Excessive Speed: Driving too fast for the conditions.
- Improper braking and steering under sway conditions
- Overloading and/or improper weight distribution.
- Not keeping lug nuts tight.
- Failure to adjust driving behavior when towing a trailer.
- Not maintaining proper tire pressure
- Improper or mis-coupling of the trailer to the hitch.

##### 2.2.1 IMPROPER SIZING OF TRAILER TO TOW VEHICLE

Trailers that weigh too much for the tow vehicle can cause stability problems, which can lead to death or serious injury. The additional strain put on the engine and drive-train may lead to serious tow vehicle maintenance problems.

Do not exceed the maximum towing capacity of your tow vehicle. The towing capacity of your tow vehicle, in terms of maximum Gross Trailer Weight (GTW) and maximum Gross Combined Weight Rating (GCWR) can be found in the tow vehicle Owner's Manual.

**⚠ DANGER**  
Use of an under-rated hitch, ball or tow vehicle can result in loss of control leading to death or serious injury.  
Make certain your hitch and tow vehicle are rated for your trailer.

##### 2.2.2 DRIVING TOO FAST

With ideal road conditions, the maximum recommended speed for safely towing a trailer is 55 mph. Driving too fast can cause the trailer to sway, thus increasing the possibility for loss of control. Also your tires may

## Introduction

### 1. INTRODUCTION

Congratulations on the purchase of your trailer. We believe you will be happy and completely satisfied with your purchase. Our goal is to provide a valued customer a quality trailer at a reasonable price.

For your safety, read and understand this manual before operating your trailer. If there are any questions about information in this manual, please consult your dealer.

When calling about your trailer, please have the VIN number available for the dealer. The VIN number is normally on the front left side of the trailer.

For future reference, please write your VIN number in the space below.

This manual covers the basic trailer. You must read, understand and follow the instructions given by the trailer manufacturer, tow vehicle and trailer hitch manufacturers. Keep all manuals provided with your trailer in a safe place at all times.

Inserts providing information on axles and tire warranty are provided with this manual. Please keep these inserts for future reference.

## Safety

### 2. SAFETY

#### 2.1 SAFETY ALERT SYMBOLS AND SIGNAL WORDS

An Owner's Manual that provides general trailer information cannot cover all of the specific details necessary for the proper combination of every trailer, tow vehicle and hitch. You must read, understand and follow the instructions given by the tow vehicle and trailer hitch manufacturers, as well as the instructions in this manual.

Our trailers are built with components produced by various manufacturers. Some of these items have separate instruction manuals. Where this manual indicates that you should read another manual, and you do not have that manual, contact your dealer for assistance.

The safety information in this manual is denoted by the safety alert symbol:



This symbol means ATTENTION! BECOME ALERT! YOUR SAFETY IS INVOLVED!

The level of risk is indicated by the following signal words:

#### DANGER

**DANGER** - Indicates a hazardous situation, which, if not avoided, WILL result in death or serious injury.

#### WARNING

**WARNING** - Indicates a hazardous situation, which, if not avoided, could result in death or serious injury.

#### CAUTION

**CAUTION** - Indicates a hazardous situation, which, if not avoided, could result in minor or moderate injury.

#### NOTICE

**NOTICE** - Indicates a situation that could result in damage to the equipment or other property.

#### 2.2 MAJOR HAZARDS

Loss of control of the trailer or trailer/tow vehicle combination can result in death or serious injury. The most common causes for loss of control of the trailer are:

- Improper sizing the trailer for the tow vehicle, or vice versa.
- Excessive Speed: Driving too fast for the conditions.
- Improper braking and steering under sway conditions
- Overloading and/or improper weight distribution.
- Not keeping lug nuts tight.
- Failure to adjust driving behavior when towing a trailer.
- Not maintaining proper tire pressure
- Improper or mis-coupling of the trailer to the hitch.

##### 2.2.1 IMPROPER SIZING OF TRAILER TO TOW VEHICLE

Trailers that weigh too much for the tow vehicle can cause stability problems, which can lead to death or serious injury. The additional strain put on the engine and drive-train may lead to serious tow vehicle maintenance problems.

Do not exceed the maximum towing capacity of your tow vehicle. The towing capacity of your tow vehicle, in terms of maximum Gross Trailer Weight (GTW) and maximum Gross Combined Weight Rating (GCWR) can be found in the tow vehicle Owner's Manual.

#### DANGER

**Use of an under-rated hitch, ball or tow vehicle can result in loss of control leading to death or serious injury.**

**Make certain your hitch and tow vehicle are rated for your trailer.**

##### 2.2.2 DRIVING TOO FAST

With ideal road conditions, the maximum recommended speed for safely towing a trailer is 55 mph. Driving too fast can cause the trailer to sway, thus increasing the possibility for loss of control. Also your tires may

## Safety

overheat, increasing the possibility of a blowout.

### WARNING

**Driving too fast for conditions can result in loss of control and cause death or serious injury.**

**Adjust speed down when towing trailer.**

### 2.2.3 ADJUST DRIVING WHEN TOWING TRAILER

When towing a trailer, you will have decreased acceleration, increased stopping distance, and increased turning radius.

The trailer will change the handling characteristics of the tow vehicle, making it more sensitive to steering inputs and more likely to be pushed around in windy conditions or when being passed by large vehicles. In addition, you will need a longer distance to pass, due to slower acceleration and increased length. With this in mind:

- When encountering trailer sway, take your foot off the accelerator, and steer as little as possible in order to stay on the road. Use small "trim-like" steering adjustments. Do not attempt to steer out of the sway; you'll only make it worse. Also do not apply the tow vehicle brakes to correct trailer swaying. On the other hand, application of the trailer brakes alone will tend to straighten out the combination, especially when going downhill.
- Check rearview mirrors frequently to observe trailer and traffic.
- Be aware of trailer height, especially when approaching bridges, roofed areas and trees.
- Be alert for slippery conditions. You are more likely to be affected by slippery road surfaces when driving a tow vehicle with a trailer, than driving a tow vehicle without a trailer.
- Anticipate the trailer "swaying." Swaying can be caused by excessive steering, wind gusts, roadway edges, or by the trailer reaction to the pressure wave created by passing trucks and busses.
- Use lower gear when driving down steep or long grades. Use the engine and transmission as a brake. Do not ride the brakes, as they can overheat and become ineffective.

### 2.2.4 TRAILER NOT PROPERLY COUPLED TO HITCH

It is critical that the trailer be securely coupled to the hitch, and that the safety chains and emergency breakaway brake lanyard are correctly attached. Uncoupling may result in death or serious injury to you and to others.

### WARNING

Proper selection and condition of the receiver and hitch are essential to safe towing a trailer.

**A loss of coupling may result in death or serious injury.**

Hitch size must match receiver size.

**Be sure hitch load rating is equal to or greater than load rating of the receiver.**

**Be sure hitch components are tight before coupling trailer to tow vehicle.**

**Observe hitch for wear, corrosion and cracks before coupling. Replace worn, corroded or cracked hitch components before coupling trailer to tow vehicle.**

### WARNING

**An improperly coupled trailer can result in death or serious injury. Do not move trailer until:**

- Receiver is secured and locked to tow vehicle.
- Safety chains are secured to tow vehicle.
- Trailer jack(s) are fully retracted.
- Trailer brakes are checked.
- Tires and wheels are checked.
- Breakaway switch is connected to vehicle;
- The trailer lights are connected and checked.
- Load is secured to trailer.

## Safety

### 2.2.5 PROPER USE OF SAFETY CHAINS

Safety chains are provided so that control of the trailer can be maintained if your trailer comes loose from the hitch.

### WARNING

**Improper rigging of the safety chains can result in loss of control of the trailer and tow vehicle, leading to death or serious injury, if the trailer uncouples from the tow vehicle.**

**Fasten chains to safety chain receivers on hitch, not to ball.**

**Have sufficient slack to permit turning and to keep gooseneck on bed of tow vehicle, if the trailer comes loose.**

### 2.2.6 PROPER CONNECTION OF BREAKAWAY BRAKE

If equipped with brakes, your trailer will be equipped with a breakaway brake system that can apply the brakes on your trailer if your trailer comes loose from the hitch. You may have a separate set of instructions for the breakaway brake if the trailer is so equipped. The breakaway brake system, including battery, must be in good condition and properly rigged to be effective.

### WARNING

**An ineffective or inoperative breakaway brake system can result in a runaway trailer, leading to death or serious injury if the receiver or hitch fails.**

**Breakaway lanyard must be connected to the tow vehicle, NOT to any part of the hitch.**

**Before towing trailer, test the function of the breakaway brake system. If the breakaway brake system is not working, do not tow the trailer. Have it serviced or repaired.**

### 2.2.7 MATCHING TRAILER AND HITCH

### DANGER

**Be sure hitch and tow vehicle are rated for the Gross Vehicle Weight Rating (GVWR) of your trailer.**

**Use of a hitch with a load rating less than the load rating of the trailer can result in loss of control and may lead to death or serious injury.**

**Use of a tow vehicle with a towing capacity less than the load rating of the trailer can result in loss of control, and may lead to death or serious injury.**

### 2.2.8 WORN TIRES, LOOSE WHEELS AND LUG NUTS

Inspect all trailer tires before each tow. If a tire has a bald spot, bulge, cut, cracks, or is showing any cords, replace the tire before towing.

If a tire has uneven tread wear, take the trailer to a trailer service center for diagnosis. Uneven tread wear can be caused by tire imbalance, axle misalignment or incorrect inflation.

Tires with too little tread will not provide adequate frictional forces on wet roadways and can result in loss of control, leading to death or serious injury.

Improper tire pressure causes increased tire wear and may reduce trailer stability, which can result in a tire blowout or possible loss of control. Therefore, before each tow you must also check the tire pressure.

The proper tire pressure is listed on the Certification / VIN label, normally mounted on the front left side of the trailer, and should be checked when tires are cold. Allow 3 hours cool-down after driving as much as 1 mile at 40 mph before checking tire pressure.

## Safety

### WARNING

Inflate tires to pressure stated on the Certification / VIN label.

Improper tire pressure may cause unstable trailer. Blowout and loss of control may occur. Death or serious injury can result.

Make sure of proper tire pressure before towing trailer.

The tightness of the wheel nuts or bolts is very important in keeping the wheels properly seated to the hub. Before each tow, check to make sure they are tight.

### WARNING

Metal creep between the wheel rim and wheel nuts or bolts may cause rim to loosen.

Death or injury can occur if wheel comes off.

Tighten lug nuts or bolts before each tow.

The proper tightness (torque) for wheel nuts or bolts and tightening sequence is listed in the Inspection, Service and Maintenance section of this manual. Use a torque wrench to tighten the lug nuts and use the crisscross star pattern sequence. Improper tightening of the lug nuts voids the axle warranty.

Wheel nuts or bolts are also prone to loosen after first being assembled. When driving a new trailer (or after wheels have been remounted), check to make sure they are tight after the first 10, 25 and 50 miles of driving and before each tow thereafter.

Failure to perform this check can result in a wheel separating from the trailer and a crash, leading to death or serious injury.

### WARNING

Wheel nuts or bolts are prone to loosen after being first assembled. Death or serious injury can result.

Check wheel nuts or bolts for tightness on a new trailer, and after re-mounting a wheel at 10, 25 and 50 miles.

### WARNING

Inadequate wheel nut or bolt torque can cause a wheel to separate from the trailer, leading to death or serious injury.

Verify wheel nuts or bolts are tight before each tow.

#### 2.2.9 IMPROPER LOADING

The total weight of the load you put on the trailer, plus the empty weight of the trailer itself, must not exceed the trailer's Gross Vehicle Weight Rating (GVWR).

If you do not know the empty weight of the trailer plus the cargo weight, you must weigh the loaded trailer at a commercial scale. In addition, you must distribute the load in the trailer such that the load on any axle does not exceed the Gross Axle Weight Rating (GAWR).

If your trailer is equipped with a Tire & Loading Information Placard, mounted next to the Certification / VIN label, the cargo capacity weight stated on that placard is only a close estimate. The GVWR and GAWR are listed on the Certification / VIN label normally located on the front left side of the trailer.

### WARNING

An overloaded trailer can result in failure or loss of control of the trailer, leading to death or serious injury.

Never load a trailer so that the weight on any tire exceeds its rating.

Never exceed the trailer Gross Vehicle Weight Rating (GVWR) or axle Gross Axle Weight Rating (GAWR).

## Safety

#### 2.2.10 UNSAFE LOAD DISTRIBUTION

Improper front/rear load distribution can lead to an unstable trailer or poor tow vehicle handling. Poor trailer stability results from tongue weights that are too low, and poor tow vehicle stability results from tongue weights that are too high.

Refer to the "Loading And Unloading" section for more information.

The rule of thumb is that 20-25% percentage of total weight of the trailer plus its cargo (Gross Trailer Weight, or "GTW") that should be on the tongue of the trailer.

For example, a gooseneck trailer with a loaded weight of 6,000 pounds, should have 20-25% of 6,000 pounds (1200-1500 lbs.) on the hitch.

The numbers quoted are for example purposes only and should be tailored to the specific trailer.

For questions regarding the actual percent of tongue weight for the trailer, check with the manufacturer or specifics.

The trailer will have the proper weight distribution if the load is evenly distributed in the dump body.

For non-flowable (discrete) loads locate the load such as to provide the proper tongue weight. After loading, be sure to check that none of the axles are overloaded.

Uneven left/right load distribution can cause tire, wheel, axle or structural failure.

Be sure your trailer is evenly loaded left / right. Towing stability also depends on keeping the center of gravity as low as possible.

### WARNING

Improper tongue weight (load distribution) can result in loss of control of the trailer, leading to death or serious injury.

Make certain that tongue weight is within the allowable range.

Be sure to:

- Distribute the load evenly, right and left.
- Keep the center of gravity low.
- Distribute the load front-to-rear to provide proper tongue weight.

A flowable load must be evenly distributed throughout the body.

#### 2.2.11 SHIFTING CARGO

Since the trailer "ride" can be bumpy and rough, you must secure the cargo so that it does not shift while the trailer is being towed.

### WARNING

A shifting load can result in failure, or to loss of control of the trailer, and can lead to death or serious injury.

You must tie down all loads with proper sized fasteners, chains, straps, etc. to prevent the load from shifting while towing.

If the door latch is equipped with a catch that has a hole for a linchpin, use a linchpin to prevent the door latch from opening.

### WARNING

If a door opens, your cargo may be ejected onto the road, resulting in death or serious injury to other drivers.

Always secure door latch after closing.

Place a linchpin in the catch.

## Safety

### 2.2.12 INAPPROPRIATE CARGO

The trailer may be designed for specific cargo. If your trailer is designed for specific cargo, only carry that cargo in the trailer. A trailer must not be used to carry certain items, such as people, containers of hazardous substances or containers of flammable substances.

#### WARNING

**Do not transport people inside or on your trailer. Besides putting their lives at risk, the transport of people in or on a trailer is illegal.**

#### WARNING

**Do not transport flammable, explosive, poisonous or other dangerous materials in your trailer.**

**The exception is fuel in the tank of a vehicle or equipment being hauled.**

### 2.2.13 INOPERABLE BRAKES OR LIGHTS

If your trailer has electric brakes, your tow vehicle will have an electric brake controller that sends power to the trailer brakes.

Before towing the trailer, you must operate the brake controller while trying to pull the trailer in order to confirm that the electric brakes operate. While towing the trailer at less than 5 mph, manually operate the electric brake controller in the tow vehicle cab. You should feel the operation of the trailer brakes.

Be sure that the electric brakes and all of the lights on your trailer are functioning properly before towing the trailer. Electric brakes and lights on a trailer are controlled via a connection to the tow vehicle, generally a multi-pin electrical connector.

#### WARNING

**Improper electrical connection between the tow vehicle and the trailer will result in inoperable lights and electric brakes, and can lead to collision.**

Before each tow:

- Check that the electric brakes work by operating the brake controller inside the tow vehicle.
- Check that all lights and turn signals work.

You must provide mirrors that allow you to safely observe approaching traffic. Standard mirrors usually do not provide adequate visibility for viewing traffic to the sides and rear of a towed trailer.

### 2.2.14 TRAILER MODIFICATIONS

Modification of the trailer structure or alteration of your trailer can make the trailer unsafe and will void all warranty options. Before making any alteration to the trailer, contact your dealer or the manufacturer and describe the alteration you are contemplating.

### 2.2.15 DUMP TRAILER HAZARDS

A dump trailer is specifically designed for hauling cargo that is to be dumped. A dump trailer is not designed for transporting livestock and/or horses. The major hazards associated with dump trailers are:

- Overloading.
- Improper weight distribution; both side to side and front to rear.
- Modifying or altering dump controls.
- Not dumping from a solid and level foundation.
- Not fully opening rear doors when dumping.
- Getting under a raised dump body.
- Not using, or improperly using the body prop.
- Modifying or altering hydraulic components.
- Jerking the trailer, or hydraulics, to loosen the load.
- Trailer contacting or coming near overhead power lines when body is raised.

## Safety

### 2.2.16 TRAILER TOWING GUIDE

Driving a vehicle with a trailer in tow is vastly different from driving the same vehicle without a trailer in tow. Acceleration, maneuverability and braking are all diminished with a trailer in tow. It takes longer to get up to speed; you need more room to turn and pass, and more distance to stop when towing a trailer.

You will need to spend time adjusting to the different feel and maneuverability of the tow vehicle with a loaded trailer. Because of the significant differences in all aspects of maneuverability when towing a trailer, the hazards and risks of injury are also much greater than when driving without a trailer.

You are responsible for keeping your vehicle and trailer in control, and for all the damage that is caused if you lose control of your vehicle and trailer.

Find an open area with little or no traffic for your first practice. Before you start towing the trailer, you must follow all of the instructions for inspection, testing, loading and coupling. Also, before you start towing, adjust the mirrors so you can see the trailer as well as the area to the rear of it.

Drive slowly at first, 5 mph or so, and turn the wheel to get the feel of how the tow vehicle and trailer combination responds. Next, make some right and left hand turns. Watch in your side mirrors to see how the trailer follows the tow vehicle. Turning with a trailer attached requires more room.

Stop the rig a few times from speeds no greater than 10 mph. If your trailer is equipped with brakes, try using different combinations of trailer/electric brake and tow vehicle brake. Note the effect that the trailer brakes have when they are the only brakes used. When properly adjusted, the trailer brakes will come on just before the tow vehicle brakes.

It will take practice to learn how to back up a tow vehicle with a trailer attached. Take it slow. Before backing up, get out of the tow vehicle and look behind the trailer to make sure that there are no obstacles.

Some drivers place their hands at the bottom of the steering wheel, and while the tow vehicle is in reverse, "think" of the hands as being on the top of the wheel. When the hands move to the right (counter-clockwise, as you would do to turn the tow vehicle to the left when moving forward), the rear of the trailer moves to the right.

#### DANGER

**NEVER alter or substitute any hydraulic system component. Death or serious injury may result.**

**An altered or component substituted hydraulic system may malfunction, resulting in the dump body falling without warning.**

**NEVER alter or substitute any hydraulic system component.**

#### WARNING

**Electrocution hazard.**

**Dump body coming near or contacting power lines can cause electrocution.**

**Electrocution can occur without contact.**

**Verify there are no overhead power lines over or near the trailer before raising dump body.**

#### WARNING

**A soft and/or uneven surface may cause tow vehicle and trailer to tip over when dump body is raised.**

**Raise dump body ONLY if tow vehicle and trailer are both on a firm and level surface.**

#### WARNING

**An overloaded trailer or improperly distributed load can result in death or serious injury.**

**An overloaded trailer can cause hydraulic system to malfunction, resulting in dump body falling.**

**A load that is improperly distributed in the trailer can result in the trailer tipping over when the dump body is raised.**

## Safety

Conversely, rotating the steering wheel clockwise with your hands at the bottom of the wheel will move the rear of the trailer to the left, while backing up. Be careful not to allow the trailer to turn too much, because it will hit the rear of the tow vehicle. To straighten the rig, either pull forward, or turn the steering wheel in the opposite direction.

### 2.2.17 SAFE TRAILER TOWING GUIDELINES

Before towing, check coupling, safety chain, brakes, tires, wheels and lights.

Check the lug nuts or bolts for tightness.

Recheck the load tie downs to make sure the load will not shift during towing.

Check receiver tightness after towing 50 miles.

Adjust the brake controller to engage the trailer brakes before the tow vehicle brakes. Follow the brake controller manufacturer's literature.

Use your mirrors to verify that you have room to change lanes or pull into traffic.

Use your turn signals well in advance.

Allow plenty of stopping space for your trailer and tow vehicle.

Use lower gears for climbing and descending grades.

Do not ride the brakes while descending grades; they may get so hot that they stop working. Then you will potentially have a runaway tow vehicle and trailer.

Do not apply the tow vehicle brakes to correct extreme trailer swaying. Instead, lightly apply the trailer brakes with the hand controller.

Make regular stops, about once each hour. Confirm that:

- The receiver is secure to the hitch and is locked.
- Electrical connectors are made.
- There is appropriate slack in safety chains.
- There is appropriate slack in breakaway lanyard.
- The tires are not visibly low on pressure.
- The cargo is secure and in good condition.

Slow down for bumps in the road.

Do not brake while in a curve unless absolutely necessary. Instead, slow down before you enter the curve.

Do not drive so fast that the trailer begins to sway due to speed. Generally never drive faster than 55 m.p.h.

Allow plenty of room for passing. A rule of thumb is that the passing distance with a trailer is 4 times the passing distance without a trailer.

## 2.2.18 SAFETY WARNING LABELS ON YOUR TRAILER

## Safety

<p><b>⚠ WARNING</b></p> <p>Lights can prevent trailer from being hit by other vehicles. You must:</p> <ol style="list-style-type: none"> <li>1. CONNECT trailer and tow vehicle electrical connectors.</li> <li>2. CHECK all lights: tail lights, turn signal, and brake lights.</li> <li>3. DO NOT TOW if lights are not working.</li> </ol> <p>© 2002 NATM</p>	<p>DISCONNECTED    CONNECTED</p>   <p>UT0027</p>
--	--

<p><b>⚠ WARNING</b></p> <p>ALWAYS use safety chains. Chains hold trailer if connection fails. You must:</p> <ol style="list-style-type: none"> <li>1. ALLOW slack for trailer to turn.</li> <li>2. ATTACH chain hooks securely to tow vehicle frame.</li> </ol> <p>© 2002 NATM</p>	<p>ATTACH TO TOW VEHICLE STRUCTURE</p>  <p>ENOUGH SLACK FOR TURNS</p> <p>UT0021</p>
--	--

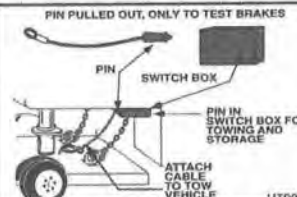
<p><b>⚠ WARNING</b></p> <p>Trailer can roll if it comes loose. Electric safety brake applies when cable pulls pin out of switch box:</p> <ol style="list-style-type: none"> <li>1. PULL hard to get pin out of switch box.</li> <li>2. CHECK brake by PULLING TRAILER with tow vehicle.</li> <li>3. ATTACH pin CABLE to tow vehicle so pin will be pulled out if trailer separates.</li> <li>4. Promptly REPLACE pin in switch box.</li> </ol> <p>© 2002 NATM</p>	<p>PIN PULLED OUT, ONLY TO TEST BRAKES</p>  <p>PIN IN SWITCH BOX FOR TOWING AND STORAGE</p> <p>ATTACH CABLE TO TOW VEHICLE</p> <p>UT0015</p>
---	---

<p><b>⚠ WARNING</b></p> <p>Improper loading can cause trailer sway and sudden loss of control. You must:</p> <ul style="list-style-type: none"> <li>• Make certain weight of load plus trailer weight does not exceed trailer's capacity (GVWR-Gross Vehicle Weight Rating).</li> <li>• Load heavier items in front of wheels.</li> <li>• Load evenly side to side.</li> <li>• SECURE load to trailer.</li> <li>• Close and PIN or LOCK doors.</li> </ul> <p>© 2002 NATM</p>	 <p>Balance load side to side</p> <p>More load in front of wheels</p> <p>Lean load in rear</p> <p>UT0024</p>
--	--

<p><b>⚠ WARNING</b></p> <p>Tire, wheel or lugnut failure can cause loss of control. Before towing, you must CHECK:</p> <ol style="list-style-type: none"> <li>1. Tire pressure and tread.</li> <li>2. Tires and wheels for damage.</li> <li>3. Lug nuts for tightness.</li> </ol> <p>For new and remounted wheels, re-tighten lug nuts at the first 10, 25 and 50 miles of driving.</p> <p>© 2002 NATM</p>	<p>Lug Nuts TIGHT?</p>  <p>Tires and Wheels OK?</p> <p>UT0019</p>
--	--





**WARNING**

To protect you and others against death or serious injury, all applicable labels shown must be on the trailer and must be legible.

If any of these labels are missing or cannot be read, contact your dealer for replacement labels.

**2.2.19 REPORTING SAFETY DEFECTS**

If you believe that your vehicle has a defect that could cause a crash or could cause injury or death, you should immediately inform the National Highway Traffic Safety Administration (NHTSA) in addition to notifying

**U-Dump Trailers**  
 2610 NW 10th St.  
 Ocala, FL 34475

If NHTSA receives similar complaints, it may open an investigation, and if it finds that a safety defect exists in a group of vehicles, it may order a recall and remedy campaign. However, NHTSA cannot become involved in individual problems between you, your dealer, or

**U-Dump Trailers**  
 2610 NW 10th St.  
 Ocala, FL 34475

To contact NHTSA, you may call the Vehicle Safety Hotline toll-free at 1-888-327-4236 (TTY: 1-800-424-9153), or go to <http://www.safercar.gov>; or write to:

Administrator, NHTSA,  
 1200 New Jersey SE,  
 Washington, DC 20590.

You can also obtain other information about motor vehicle safety from <http://www.safercar.gov>

**3. TIRE SAFETY INFORMATION**

This portion of the User's Manual contains tire safety information as required by 49 CFR 575.6.

Section 3.1 contains "Trailer Tire Information".

Section 3.2 contains "Steps for Determining Correct Load Limit - Trailer".

Section 3.3 contains "Steps for Determining Correct Load Limit - Tow Vehicle".

Section 3.4 contains a Glossary of Tire Terminology, including "cold inflation pressure", "maximum inflation pressure", "recommended inflation pressure", and other non-technical terms.

Section 3.5 contains information from the NHTSA brochure entitled "Tire Safety - Everything Rides On It".

This brochure, as well as preceding subsections, describes the following items:

- Tire labeling, including a description and explanation of each marking on the tires, and information about the DOT Tire Identification Number (TIN).
- Recommended tire inflation pressure, including a description and explanation of:
  - A. Cold inflation pressure.
  - B. Vehicle Placard and location on the vehicle.
  - C. Adverse safety consequences of under inflation (including tire failure).
  - D. Measuring and adjusting air pressure for proper inflation.
- Tire Care, including maintenance and safety practices.
- Vehicle load limits, including a description and explanation of the following items:
  - A. Locating and understanding the load limit information, total load capacity, and cargo capacity.
  - B. Calculating total and cargo capacities with varying seating configurations including quantitative examples showing / illustrating how the vehicles cargo and luggage capacity decreases as combined number and size of occupants' increases. This item is also discussed in Section 3.
  - C. Determining compatibility of tire and vehicle load capabilities.
  - D. Adverse safety consequences of overloading on handling and stopping on tires.

**3.1 TRAILER TIRE INFORMATION**

Trailer tires may be worn out even though they still have plenty of tread left. This is because trailer tires have to carry a lot of weight all the time, even when not in use.

It is actually better for the tire to be rolling down the road than to be idle. During use, the tire releases lubricants that are beneficial to tire life. Using the trailer tires often also helps prevent flat spots from developing.

The main cause of tire failure is improper inflation. Check the cold tire inflation pressures at least once a week for proper inflation levels. "Cold" means that the tires are at the same temperature as the surrounding air, such as when the vehicle has been parked overnight. Wheel and tire manufacturers recommend adjusting the air pressure to the trailer manufacturer's recommended cold inflation pressure, in pounds per square inch (PSI) stated on the vehicle's Federal Certification Label or Tire Placard when the trailer is loaded to its gross vehicle weight rating (GVWR).

If the tires are inflated to less than the recommended inflation level or the GVWR of the trailer is exceeded, the load carrying capacity of the tire could be dramatically affected. If the tires are inflated more than the recommended inflation level, handling characteristics of the tow vehicle/trailer combination could be affected. Refer to the owner's manual or talk to your dealer or vehicle manufacturer if you have any questions regarding proper inflation practices.

Tires can lose air over a period of time. In fact, tires can lose 1 to 3 PSI per month. This is because molecules of air, under pressure, weave their way from the inside of the tire, through the rubber, to the outside. A drop in tire pressure could cause the tire to become overloaded, leading to excessive heat build up. If a trailer tire is under-inflated, even for a short period of time, the tire could suffer internal damage.

High speed towing in hot conditions degrades trailer tires significantly. As heat builds up during driving, the tire's internal structure starts to breakdown, compromising the strength of the tire. It is recommended to drive at moderate speeds.

Statistics indicate the average life of a trailer tire is about five years under normal use and maintenance conditions. After three years, replacing the trailer tires with new ones should be considered, even if the tires have adequate tread depth. Some experts claim that

## Tire Safety

after five years, trailer tires are considered worn out and should be replaced, even if they have had minimal or no use. This is such a general statement that it may not apply in all cases. It is best to have your tires inspected by a tire supplier to determine if your tires need to be replaced.

If you are storing your trailer for an extended period, make sure the tires are fully inflated to the maximum rated pressure and that you store them in a cool, dry place, such as a garage. Use tire covers to protect the trailer tires from the harsh effects of the sun.

### 3.2 STEPS FOR DETERMINING CORRECT LOAD LIMIT - TRAILER

Determining the load limits of a trailer includes more than understanding the load limits of the tires alone. On all trailers there is a Federal Certification / VIN label that is located on the forward half of the left (road) side of the unit. This certification/VIN label will indicate the trailer's Gross Vehicle Weight Rating (GVWR). This is the most weight the fully loaded trailer can weigh. It will also provide the Gross Axle Weight Rating (GAWR). This is the most a particular axle can weigh. If there are multiple axles, the GAWR of each axle will be provided.

If your trailer has a GVWR of 10,000 pounds or less, there is a vehicle placard located in the same location as the certification label described above. This placard provides tire and loading information. In addition, this placard will show a statement regarding maximum cargo capacity.

Cargo can be added to the trailer, up to the maximum weight specified on the placard. The combined weight of the cargo is provided as a single number. In any case, remember: the total weight of a fully loaded trailer can not exceed the stated GVWR.

When loading your cargo, be sure it is distributed evenly to prevent overloading front to back and side to side. Heavy items should be placed low and as close to the axle positions as reasonable. Too many items on one side may overload a tire. The best way to know the actual weight of the vehicle is to weigh it at a public scale. Talk to your dealer to discuss the weighing methods needed to capture the various weights related to the trailer. This would include the weight empty or unloaded, weights per axle, wheel, hitch or king-pin, and total weight.

Excessive loads and/or underinflation cause tire

overloading and, as a result, abnormal tire flexing occurs. This situation can generate an excessive amount of heat within the tire. Excessive heat may lead to tire failure. It is the air pressure that enables a tire to support the load, so proper inflation is critical. The proper air pressure may be found on the Certification / VIN label and/or on the Tire Placard. This value should never exceed the maximum cold inflation pressure stamped on the tire.

#### 3.2.1 TRAILERS 10,000 POUNDS GVWR OR LESS

TIRE AND LOADING INFORMATION			
The weight of cargo should never exceed XXX kg. or XXX lbs.			
TIRE	SIZE	COLD TIRE PRESSURE	SEE OWNER'S MANUAL FOR ADDITIONAL INFORMATION
FRONT	20.5x8.0-10(E)	621KPA, 90PSI	
REAR			
SPARE	NONE		

1. Locate the statement, "The weight of cargo should never exceed XXX kg or XXX lbs.," on your vehicle's placard.
2. This figure equals the available amount of cargo and luggage load capacity.
3. Determine the combined weight of luggage and cargo being loaded on the vehicle. That weight may not safely exceed the available cargo and luggage load capacity.
4. The trailer's placard refers to the Tire Information Placard attached adjacent to or near the trailer's VIN (Certification) label at the left front of the trailer.

#### 3.2.2 TRAILERS OVER 10,000 POUNDS GVWR

(Note: These trailers are not required to have a tire information placard on the trailer and may not have one installed)

1. Determine the empty weight of your trailer by weighing the trailer using a public scale or other means.
2. Locate the GVWR (Gross Vehicle Weight Rating) of the trailer on your trailer's VIN (Certification) label.
3. Subtract the empty weight of your trailer from the GVWR stated on the VIN label. That weight is the maximum available cargo capacity of the trailer and may not be safely exceeded. National Highway Transportation Safety Administration (NHTSA) in addition to notifying us.

## Tire Safety

### 3.3 STEPS FOR DETERMINING CORRECT LOAD LIMIT - TOW VEHICLE

1. Locate the statement: "The combined weight of occupants and cargo should never exceed XXX lbs.," on your vehicle's placard.
2. Determine the combined weight of the driver and passengers who will be riding in your vehicle.
3. Subtract the combined weight of the driver and passengers from XXX kilograms or XXX pounds.
4. The resulting figure equals the available amount of cargo and luggage capacity. For example, if the "XXX" amount equals 1400 lbs. and there will be five 150 lb. passengers in your vehicle, the amount of available cargo and luggage capacity is 650 lbs. (1400-750 (5 x 150) = 650 lbs.).
5. Determine the combined weight of luggage and cargo being loaded on the vehicle. That weight may not safely exceed the available cargo and luggage capacity calculated in previous step.
6. If your vehicle will be towing a trailer, load from your trailer will be transferred to your vehicle. Consult the tow vehicle's manual to determine how this weight transfer reduces the available cargo and luggage capacity of your vehicle.

### 3.4 GLOSSARY OF TIRE TERMINOLOGY

**Accessory weight:** The combined weight (in excess of those standard items which may be replaced) of automatic transmission, power steering, power brakes, power windows, power seats, radio and heater, to the extent that these items are available as factory-installed equipment (whether installed or not).

**Bead:** The part of the tire that is made of steel wires, wrapped or reinforced by ply cords and that is shaped to fit the rim.

**Bead separation:** This is the breakdown of the bond between components in the bead.

**Bias ply tire:** A pneumatic tire in which the ply cords that extend to the beads are laid at alternate angles substantially less than 90 degrees to the centerline of the tread.

**Carcass:** The tire structure, except tread and sidewall rubber which, when inflated, bears the load.

**Chunking:** The breaking away of pieces of the tread or sidewall.

**Cold inflation pressure:** The pressure in the tire before you drive.

**Cord:** The strands forming the plies in the tire.

**Cord separation:** The parting of cords from adjacent rubber compounds.

**Cracking:** Any parting within the tread, sidewall, or inner liner of the tire extending to cord material.

**CT:** A pneumatic tire with an inverted flange tire and rim system in which the rim is designed with rim flanges pointed radially inward and the tire is designed to fit on the underside of the rim in a manner that encloses the rim flanges inside the air cavity of the tire.

**Curb weight:** The weight of a motor vehicle with standard equipment including the maximum capacity of fuel, oil, and coolant, and, if so equipped, air conditioning and additional weight optional engine.

**Extra load tire:** A tire designed to operate at higher loads and at higher inflation pressures than the corresponding standard tire.

**Groove:** The space between two adjacent tread ribs.

**Gross Axle Weight Rating:** The maximum weight that any axle can support, as published on the Certification / VIN label on the front left side of the trailer. Actual weight determined by weighing each axle on a public scale, with the trailer attached to the towing vehicle.

**Gross Vehicle Weight Rating:** The maximum weight of the fully loaded trailer, as published on the Certification / VIN label. Actual weight determined by weighing trailer on a public scale, without being attached to the towing vehicle.

**Hitch Weight:** The downward force exerted on the hitch ball by the trailer coupler.

**Innerliner:** The layer(s) forming the inside surface of a tubeless tire that contains the inflating medium within the tire.

**Innerliner separation:** The parting of the innerliner from cord material in the carcass.

**Intended outboard sidewall:** The sidewall that contains a white-wall, bears white lettering or bears manufacturer, brand, and/or model name molding that

## Tire Safety

is higher or deeper than the same molding on the other sidewall of the tire or the outward facing sidewall of an asymmetrical tire that has a particular side that must always face outward when mounted on a vehicle.

**Light truck (LT) tire:** A tire designated by its manufacturer as primarily intended for use on lightweight trucks or multipurpose passenger vehicles. May be used on trailers.

**Load rating:** The maximum load that a tire is rated to carry for a given inflation pressure.

**Maximum load rating:** The load rating for a tire at the maximum permissible inflation pressure for that tire.

**Maximum permissible inflation pressure:** The maximum cold inflation pressure to which a tire may be inflated.

**Maximum loaded vehicle weight:** The sum of curb weight, accessory weight, vehicle capacity weight, and production options weight.

**Measuring rim:** The rim on which a tire is fitted for physical dimension requirements.

**Non-pneumatic rim:** A mechanical device which, when a non-pneumatic tire assembly incorporates a wheel, supports the tire, and attaches, either integrally or separably, to the wheel center member and upon which the tire is attached.

**Non-pneumatic spare tire assembly:** A non-pneumatic tire assembly intended for temporary use in place of one of the pneumatic tires and rims that are fitted to a passenger car in compliance with the requirements of this standard.

**Non-pneumatic tire:** A mechanical device which transmits, either directly or through a wheel or wheel center member, the vertical load and tractive forces from the roadway to the vehicle, generates the tractive forces that provide the directional control of the vehicle and does not rely on the containment of any gas or fluid for providing those functions.

**Non-pneumatic tire assembly:** A non-pneumatic tire, alone or in combination with a wheel or wheel center member, which can be mounted on a vehicle.

**Normal occupant weight:** This means 68 kilograms (150 lbs.) times the number of occupants specified in the second column of Table I of 49 CFR 571.110.

**Occupant distribution:** The distribution of occupants in a vehicle as specified in the third column of Table I of 49 CFR 571.110.

**Open splice:** Any parting at any junction of tread, sidewall, or innerliner that extends to cord material.

**Outer diameter:** The overall diameter of an inflated new tire.

**Overall width:** The linear distance between the exteriors of the sidewalls of an inflated tire, including elevations due to labeling, decorations, or protective bands or ribs.

**Pin Weight:** The downward force applied to the 5th wheel or gooseneck ball, by the trailer kingpin or gooseneck coupler.

**Ply:** A layer of rubber-coated parallel cords.

**Ply separation:** A parting of rubber compound between adjacent plies.

**Pneumatic tire:** A mechanical device made of rubber, chemicals, fabric and steel or other materials, that, when mounted on an automotive wheel, provides the traction and contains the gas or fluid that sustains the load.

**Production options weight:** The combined weight of those installed regular production options weighing over 2.3 kilograms (5 lbs.) in excess of those standard items which they replace, not previously considered in curb weight or accessory weight, including heavy duty brakes, ride levelers, roof rack, heavy duty battery, and special trim.

**Radial ply tire:** A pneumatic tire in which the ply cords that extend to the beads are laid at substantially 90 degrees to the centerline of the tread.

**Recommended inflation pressure:** This is the inflation pressure provided by the vehicle manufacturer on the Tire Information label and on the Certification / VIN tag.

**Reinforced tire:** A tire designed to operate at higher loads and at higher inflation pressures than the corresponding standard tire.

**Rim:** A metal support for a tire or a tire and tube assembly upon which the tire beads are seated.

## Tire Safety

**Rim diameter:** This means the nominal diameter of the bead seat.

**Rim size designation:** This means the rim diameter and width.

**Rim type designation:** This means the industry of manufacturer's designation for a rim by style or code.

**Rim width:** This means the nominal distance between rim flanges.

**Section width:** The linear distance between the exteriors of the sidewalls of an inflated tire, excluding elevations due to labeling, decoration, or protective bands.

**Sidewall:** That portion of a tire between the tread and bead.

**Sidewall separation:** The parting of the rubber compound from the cord material in the sidewall.

**Special Trailer (ST) tire:** The "ST" is an indication the tire is for trailer use only.

**Test rim:** The rim on which a tire is fitted for testing, and may be any rim listed as appropriate for use with that tire.

**Tread:** That portion of a tire that comes into contact with the road.

**Tread rib:** A tread section running circumferentially around a tire.

**Tread separation:** Pulling away of the tread from the tire carcass.

**Treadwear indicators (TWI):** The projections within the principal grooves designed to give a visual indication of the degrees of wear of the tread.

**Vehicle capacity weight:** The rated cargo and luggage load plus 68 kilograms (150 lbs.) times the vehicle's designated seating capacity.

**Vehicle maximum load on the tire:** The load on an individual tire that is determined by distributing to each axle its share of the maximum loaded vehicle weight and dividing by two.

**Vehicle normal load on the tire:** The load on an

individual tire that is determined by distributing to each axle its share of the curb weight, accessory weight, and normal occupant weight (distributed in accordance with Table I of CRF 49 571.110) and dividing by 2.

**Weather side:** The surface area of the rim not covered by the inflated tire.

**Wheel center member:** In the case of a non-pneumatic tire assembly incorporating a wheel, a mechanical device which attaches, either integrally or separably, to the non-pneumatic rim and provides the connection between the nonpneumatic rim and the vehicle; or, in the case of a non-pneumatic tire assembly not incorporating a wheel, a mechanical device which attaches, either integrally or separably, to the non-pneumatic tire and provides the connection between tire and the vehicle.

**Wheel-holding fixture:** The fixture used to hold the wheel and tire assembly securely during testing.

### 3.5 TIRE SAFETY - EVERYTHING RIDES ON IT

The National Traffic Safety Administration (NHTSA) has published a brochure (DOT HS 809 361) that discusses all aspects of Tire Safety, as required by CFR 575.6. This brochure is reproduced in part below. It can be obtained and downloaded from NHTSA, free of charge, from the following web site:

[http://www.nhtsa.dot.gov/cars/rules/TireSafety/ridesonit/tires\\_index.html](http://www.nhtsa.dot.gov/cars/rules/TireSafety/ridesonit/tires_index.html)

Studies of tire safety show that maintaining proper tire pressure, observing tire and vehicle load limits (not carrying more weight in your vehicle than your tires or vehicle can safely handle), avoiding road hazards, and inspecting tires for cuts, slashes, and other irregularities are the most important things you can do to avoid tire failure, such as tread separation or blowout and flat tires. These actions, along with other care and maintenance activities, can also:

- Improve vehicle handling
- Help protect you and others from avoidable breakdowns and accidents
- Improve fuel economy
- Increase the life of your tires.

This booklet presents a comprehensive overview of tire safety, including information on the following topics:

- Basic tire maintenance

## Tire Safety

- Uniform Tire Quality Grading System
- Fundamental characteristics of tires
- Tire safety tips.

Use this information to make tire safety a regular part of your vehicle maintenance routine. Recognize that the time you spend is minimal compared with the inconvenience and safety consequences of a flat tire or other tire failure.

### 3.5.1 SAFETY FIRST- BASIC TIRE MAINTENANCE

Properly maintained tires improve the steering, stopping, traction, and load-carrying capability of your vehicle. Underinflated tires and overloaded vehicles are a major cause of tire failure. Therefore, as mentioned above, to avoid flat tires and other types of tire failure, you should maintain proper tire pressure, observe tire and vehicle load limits, avoid road hazards, and regularly inspect your tires.

### 3.5.2 FINDING YOUR VEHICLE'S RECOMMENDED TIRE PRESSURE AND LOAD LIMITS

Tire information placards and vehicle certification labels contain information on tires and load limits. These labels indicate the vehicle manufacturer's information including:

- Recommended tire size
- Recommended tire inflation pressure
- Vehicle capacity weight (VCW—the maximum occupant and cargo weight a vehicle is designed to carry)
- Front and rear gross axle weight ratings (GAWR—the maximum weight the axle systems are designed to carry)
- Both placards and certification labels are permanently attached to the trailer near the left front

### 3.5.3 UNDERSTANDING TIRE PRESSURE AND LOAD LIMITS

Tire inflation pressure is the level of air in the tire that provides it with load-carrying capacity and affects the overall performance of the vehicle. The tire inflation pressure is a number that indicates the amount of air pressure—measured in pounds per square inch (psi)—a tire requires to be properly inflated. (You will also find this number on the vehicle information placard expressed in kilopascals (kPa), which is the metric measure used internationally.)

Manufacturers of passenger vehicles and light trucks

determine this number based on the vehicle's design load limit, that is, the greatest amount of weight a vehicle can safely carry and the vehicle's tire size. The proper tire pressure for your vehicle is referred to as the "recommended cold inflation pressure." (As you will read below, it is difficult to obtain the recommended tire pressure if your tires are not cold.)

Because tires are designed to be used on more than one type of vehicle, tire manufacturers list the "maximum permissible inflation pressure" on the tire sidewall. This number is the greatest amount of air pressure that should ever be put in the tire under normal driving conditions.

### 3.5.4 SAFETY FIRST- BASIC TIRE MAINTENANCE

It is important to check your vehicle's tire pressure at least once a month for the following reasons:

- Most tires may naturally lose air over time.
- Tires can lose air suddenly if you drive over a pothole or other object or if you strike the curb when parking.
- With radial tires, it is usually not possible to determine under inflation by visual inspection.

For convenience, purchase a tire pressure gauge to keep in your vehicle. Gauges can be purchased at tire dealerships, auto supply stores, and other retail outlets. The recommended tire inflation pressure that vehicle manufacturers provide reflects the proper psi when a tire is cold. The term cold does not relate to the outside temperature. Rather, a cold tire is one that has not been driven on for at least three hours. When you drive, your tires get warmer, causing the air pressure within them to increase. Therefore, to get an accurate tire pressure reading, you must measure tire pressure when the tires are cold or compensate for the extra pressure in warm tires.

### 3.5.5 STEPS FOR MAINTAINING PROPER TIRE PRESSURE

1. Locate the recommended tire pressure on the vehicle's tire information placard, certification label, or in the owner's manual.
2. Record the tire pressure of all tires.
3. If the tire pressure is too high in any of the tires, slowly release air by gently pressing on the tire valve stem with the edge of your tire gauge until you get to the correct pressure.
4. If the tire pressure is too low, note the difference between the measured tire pressure and the correct tire pressure. These "missing" pounds of pressure

are what you will need to add.

5. At a service station, add the missing pounds of air pressure to each tire that is under inflated.
6. Check all the tires to make sure they have the same air pressure except in cases in which the front and rear tires are supposed to have different amounts of pressure).

If you have been driving your vehicle and think that a tire is under inflated, fill it to the recommended cold inflation pressure indicated on your vehicle's tire information placard or certification label. While your tire may still be slightly under inflated due to the extra pounds of pressure in the warm tire, it is safer to drive with air pressure that is slightly lower than the vehicle manufacturer's recommended cold inflation pressure than to drive with a significantly under inflated tire. Since this is a temporary fix, don't forget to recheck and adjust the tire's pressure when you can obtain a cold reading.

### 3.5.6 TIRE SIZE

To maintain tire safety, purchase new tires that are the same size as the vehicle's original tires or another size recommended by the manufacturer. Look at the tire information placard, the owner's manual, or the sidewall of the tire you are replacing to find this information. If you have any doubt about the correct size to choose, consult with the tire dealer.

### 3.5.7 TIRE TREAD

The tire tread provides the gripping action and traction that prevent your vehicle from slipping or sliding, especially when the road is wet or icy. In general, tires are not safe and should be replaced when the tread is worn down to 2/32 of an inch. Tires have built-in tread wear indicators that let you know when it is time to replace your tires. These indicators are raised sections spaced intermittently in the bottom of the tread grooves. When they appear "even" with the outside of the tread, it is time to replace your tires. Another method for checking tread depth is to place a penny in the tread with Lincoln's head upside down and facing you. If you can see the top of Lincoln's head, you are ready for new tires.

### 3.5.8 TIRE BALANCE AND WHEEL ALIGNMENT

To avoid vibration or shaking of the vehicle when a tire rotates, the tire must be properly balanced. This balance is achieved by positioning weights on the wheel to counterbalance heavy spots on the wheel-and-tire assembly. A wheel alignment adjusts the angles of the

## Tire Safety

wheels so that they are positioned correctly relative to the vehicle's frame. This adjustment maximizes the life of your tires. These adjustments require special equipment and should be performed by a qualified technician.

### 3.5.9 TIRE REPAIR

The proper repair of a punctured tire requires a plug for the hole and a patch for the area inside the tire that surrounds the puncture hole. Punctures through the tread can be repaired if they are not too large, but punctures to the sidewall should not be repaired. Tires must be removed from the rim to be properly inspected before being plugged and patched.

### 3.5.10 TIRE FUNDAMENTALS

Federal law requires tire manufacturers to place standardized information on the sidewall of all tires. This information identifies and describes the fundamental characteristics of the tire and also provides a tire identification number for safety standard certification and in case of a recall.

#### 3.5.10.1 INFORMATION ON PASSENGER VEHICLE TIRES



P: The "P" indicates the tire is for passenger vehicles.

**Next number:** This three-digit number gives the width in millimeters of the tire from sidewall edge to sidewall edge. In general, the larger the number, the wider the tire.

**Next number:** This two-digit number, known as the aspect ratio, gives the tire's ratio of height to width.

## Coupling To Tow Vehicle

### 4. COUPLING TO TOW VEHICLE

Follow all of the safety precautions and instructions in this manual to ensure safety of persons, cargo, and satisfactory life of the trailer.

#### 4.1 TOW VEHICLE AND HITCH

If the vehicle and hitch are not properly selected and matched to the Gross Vehicle Weight Rating (GVWR) of your trailer, you can cause an accident that could lead to death or serious injury. If you already have a tow vehicle, know your vehicle tow rating and make certain the trailer's rated capacity is less than or equal to the tow vehicle's rated towing capacity.

#### **! DANGER**

Use of a tow vehicle with a towing capacity less than the load rating of the trailer can result in loss of control, and may lead to death or serious injury.

Use of a hitch with a load rating less than the load rating of the trailer can result in loss of control and may lead to death or serious injury.

Verify hitch and tow vehicle are rated for the Gross Vehicle Weight Rating of your trailer.

#### 4.1.1 TRAILER INFORMATION

The Certification / Vehicle Identification Number (VIN) tag is located on the front left side of the trailer.

The trailer Certification / VIN tag contains the following critical safety information for the use of your trailer:

**MANUFACTURER:** Name of trailer manufacturer.

**DATE OF MANUFACTURE:** Month and year the trailer was manufactured.

**GVWR:** The Gross Vehicle Weight Rating is the maximum allowable gross weight of the trailer and its contents. The gross weight of the trailer includes the weight of the trailer and all of the items within it (such as cargo and other supplies).

**GAWR:** The Gross Axle Weight Rating is the maximum gross weight that an axle can support. It is the lowest of

axle, wheel, or tire rating. Sometimes the tire or wheel rating is lower than the axle manufacturer's rating, and will then determine GAWR.

The sum total of the GAWR for all trailer axles may be less than the GVWR for the trailer, because some of the trailer load is carried by the tow vehicle, rather than by the trailer axle(s). The total weight of the cargo and trailer must not exceed the GVWR, and the load on an axle must not exceed its GAWR.

**TIRE SIZE:** The tire size and load range for your trailer.

**RIM SIZE:** The rim size and load range for your trailer.

**PSI:** The tire air pressure (Kilopascals / Pounds per Square Inch) measured with tires cold.

**VIN:** The Vehicle Identification Number.

**VEHICLE TYPE:** Model or style of trailer.

**CERTIFICATION STATEMENT:** "This trailer meets all the Federal Motor Vehicle Safety Standards in effect on the date of manufacture shown above"

#### 4.1.2 TOW VEHICLE

When equipping a new vehicle or an older vehicle to tow a trailer, ask the vehicle dealer for advice on how to outfit the tow vehicle.

Vehicle manufacturers will provide you with the maximum towing capacities of their various models, as well as the GCWR. No amount of reinforcement will give a 100 horsepower, 2,500 pound truck the towing capacity that a 300 horsepower, 5,000 pound truck has.

### 4.2 COUPLING AND UNCOUPLING THE TRAILER

A secure coupling (or fastening) of the trailer to the tow vehicle is essential. A loss of coupling may result in death or serious injury. Therefore, you must understand and follow all of the instructions for coupling.

The following parts are involved in making a secure coupling between the trailer and tow vehicle:

**Coupling:** The trailer connecting mechanism by which the connection is actually made to the trailer hitch. This does not include any structural member, extension of the trailer frame, or brake controller.

## Coupling To Tow Vehicle

**Hitch:** The connecting mechanism including the ball support platform and ball and those components that extend and are attached to the towing vehicle, including bumpers intended to serve as hitches.

**Safety chains:** Chains permanently attached to the trailer such that if the connection comes loose, the safety chains can keep the trailer attached to the tow vehicle. With properly rigged safety chains, it is possible to keep the tongue of the trailer from digging into the road pavement, even if the coupler-to-hitch connection comes apart.

**Trailer lighting (and braking) connector:** A device that connects electrical power from the tow vehicle to the trailer. In addition, if your trailer has a separate braking system, the electrical connector will also supply power to the trailer brakes from the tow vehicle.

**Breakaway switch:** If the trailer becomes uncoupled from the tow vehicle, the breakaway switch lanyard, attached independently to the tow vehicle hitch, will pull a pin in the emergency electrical breakaway switch on the trailer. The breakaway switch is activated by a battery on the trailer to energize the trailer brakes independently of the towing vehicle.

It is important to check the state of charge of the emergency breakaway battery before each trip. Simply pull the pin out of the switch by hand and then try to pull the trailer. If you feel a significant drag force the brakes are activated. Be sure to re-insert the pin in the breakaway switch. Also be sure to allow enough slack in the breakaway brake lanyard such that the switch will only activate (pin pulls out) if the connection comes loose.

**Jack:** A device on the trailer that is used to raise and lower the trailer tongue.

#### **! WARNING**

An improperly coupled trailer can result in death or serious injury. Do not move the trailer until:

- Receiver is secured and locked to hitch.
- Safety chains are secured to tow vehicle.
- Trailer jack(s) are fully retracted.
- Trailer brakes are checked.
- Tires and wheels are checked.
- Breakaway switch is connected to tow vehicle;
- The trailer lights are connected and checked.
- Load is secured to trailer.

### 4.3 COUPLE TRAILER TO TOW VEHICLE

The trailer may be equipped with a ball receiver, fifth wheel or king pin. See the appropriate section for the coupler on your trailer.

#### 4.3.1 TRAILER WITH BALL RECEIVER

A ball receiver connects to a ball that is installed in the bed of the tow vehicle.

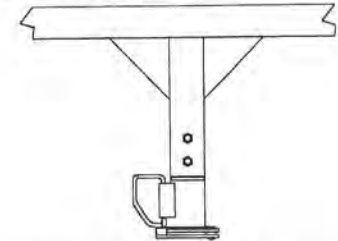

We have utilized a ball receiver that is suitable for the size and weight of the trailer. The load rating of the receiver and the necessary ball size are listed on the gooseneck.

You must provide a ball and support for your tow vehicle, that meets or exceeds the GVWR of the trailer.

The ball size must be the same as the receiver size. If the hitch ball is too small, too large, is underrated, is loose or is worn, the trailer can come loose from the tow vehicle, and may cause death or serious injury.

## Coupling To Tow Vehicle

The tow vehicle, ball and support must have a rated towing capacity equal to or greater than the trailer gross vehicle weight rating (GVWR).

It is essential that the ball be the same size as the receiver.

The ball size and load rating (capacity) are marked on the ball; hitch capacity is marked on the hitch.

### 4.3.1.1 BEFORE COUPLING TRAILER TO TOW VEHICLE

1. Be sure the size and rating of ball match the size and rating of the receiver. Hitch balls and receivers are marked with their size and rating.

#### WARNING

**Receiver-to-hitch mismatch can result in uncoupling, leading to death or serious injury.**

**Be sure the LOAD RATING of the hitch ball is equal or greater than the load rating of the receiver.**

**Be sure the SIZE of the hitch ball matches the size of the receiver.**

2. Wipe the ball clean and inspect it visually and by feel for flat spots, cracks and pits.

#### WARNING

**A worn, cracked or corroded hitch ball can fail while towing, and may result in death or serious injury.**

**Before coupling trailer, inspect the hitch ball for wear, corrosion and cracks.**

**Replace worn or damaged hitch ball.**

3. Rock the ball to make sure it is tight to the hitch, and visually check that the hitch ball is solid against the hitch frame.
4. Wipe the inside and outside of the receiver clean and inspect it visually for cracks and deformations; feel the inside of the receiver for worn spots and pits.
5. Be sure the receiver is tight to the gooseneck of the trailer. All receiver fasteners must be visibly solid against the trailer frame.

#### WARNING

**A loose gooseneck ball can result in uncoupling, leading to death or serious injury.**

**Make sure the gooseneck ball is tight to the hitch before coupling the trailer.**

6. Raise the bottom surface of the receiver to be above the top of the gooseneck ball.

### 4.3.1.2 PREPARE RECEIVER AND BALL

1. Lubricate ball and inside of receiver with a thin layer of automotive bearing grease.
2. Lower tow vehicle tailgate if equipped.
3. Remove safety latch pin and open receiver locking mechanism. In the open position, receiver is able to drop fully onto hitch ball. See the receiver instructions for details of placing the receiver in the "open" position.
4. Slowly back up tow vehicle so that hitch ball is aligned under receiver.

#### WARNING

**No one must be under the trailer or receiver during coupling.**

**Death or serious injury can occur if the trailer drops.**

### 4.3.1.3 COUPLE TRAILER TO TOW VEHICLE

1. Lower the trailer tongue until the receiver fully engages the ball. If the receiver does not line up with the hitch ball, adjust the position of the tow vehicle.
2. Close latch and engage the receiver locking mechanism. In the engaged position, the locking mechanism securely holds the receiver to the hitch ball.
3. Insert the safety lock pin through the hole in the locking mechanism.
4. Be sure the receiver is all the way on the hitch ball and the locking mechanism is engaged. A properly engaged locking mechanism will allow the receiver to raise the rear of the tow vehicle. Using the trailer jack, test to see that you can raise the rear of the tow vehicle by 1 inch, after the receiver is locked to the hitch.

## Coupling To Tow Vehicle

#### NOTICE

**The jack can be damaged by overloading. Do not use jack to raise the tow vehicle more than 1 inch.**

5. If the receiver cannot be secured to the ball, do not tow the trailer. Contact your dealer for assistance.
6. Retract the jack to its fully retracted position.

#### CAUTION

**Drop leg jacks may be spring loaded.**

**If so, they will rapidly return to the raise position when released.**

**Keep clear when releasing drop legs.**

7. Fully retract jack drop leg if equipped.
8. Raise tow vehicle tailgate if equipped.

### 4.3.1.4 CONNECT SAFETY CHAINS

1. Visually inspect the safety chains and hooks for wear or damage. Replace worn or damaged safety chains and hooks before towing.
2. Rig the safety chains so that they attach to the "safety chain receivers" on the tow vehicle. If you are not certain of the hitch provisions for receiving safety chains, contact the hitch manufacturer or installer. Do NOT attach the safety chains to the gooseneck ball or its support.
3. Rig the safety chains so they have sufficient slack to permit turning, but not too much slack – the safety chains must keep the gooseneck on the tow vehicle bed if the trailer uncouples.

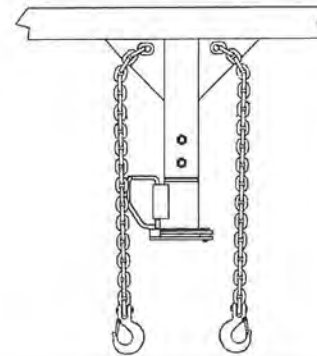

#### WARNING

**Improper rigging of the safety chains can result in loss of control of the trailer and tow vehicle, leading to death or serious injury, if the trailer uncouples from the tow vehicle.**

**Fasten chains to safety chain receivers on hitch, not to ball.**

**Have sufficient slack to permit turning and to keep gooseneck on bed of tow vehicle, if the trailer comes loose.**

### 4.3.1.5 CONNECT ELECTRICAL CABLE

1. Connect the trailer lights to the tow vehicle's electrical system using trailer electrical cable.
2. Check all lights for proper operation. Repair or replace non-working lights before towing trailer.
3. Check electric brakes for proper operation using brake controller mounted in the cab.

#### WARNING

**Improper electrical connection between the tow vehicle and the trailer will result in inoperable lights and electric brakes, and can lead to collision.**

**Before each tow:**

- Check that the electric brakes work by operating the brake controller inside the tow vehicle.
- Check that all lights and turn signals work.

### 4.3.1.6 ATTACH BREAKAWAY BRAKE LANYARD

If the receiver or hitch fails, a properly connected and working breakaway brake system will apply the trailer brakes. The safety chains will keep the tow vehicle attached and as the trailer brakes are applied, the trailer/tow vehicle combination will come to a controlled stop.

Connect the lanyard to the tow vehicle so that the hydraulic actuator will engage or the electric brake pullpin will be pulled out before all of the slack in the safety chains is taken up. Do not connect the lanyard

## Coupling To Tow Vehicle

to a safety chain, gooseneck ball or its support. This would keep the breakaway brake system from operating when it is needed.

Contact the hitch manufacturer or installer if you are not certain of the hitch provisions for the breakaway brake connection.

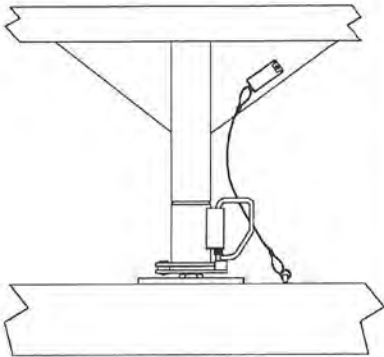

### 4.3.1.7 TEST ELECTRIC BRAKES

If your trailer has electric brakes, your tow vehicle will have an electric brake controller that sends power to the trailer brakes. Before towing the trailer on the road, you must operate the brake controller while trying to pull the trailer in order to confirm that the electric brakes operate.

While towing the trailer at less than 5 mph, manually operate the electric brake controller in the tow vehicle. You should feel the operation of the trailer brakes. If the trailer brakes are not functioning, the brake system MUST be evaluated to determine the cause of the problem and corrective action MUST be taken before the trailer is used. Take the unit to your dealer or a qualified brake specialist.

Use this procedure each time you tow the trailer to check brake system operation.

### 4.3.1.8 TEST ELECTRIC BREAKAWAY BRAKES

The breakaway brake system includes a battery, a switch with a pullpin and lanyard, and a breakaway brake controller. Read and follow the instructions here as well as the instructions that have been prepared by the breakaway brake manufacturer. If you do not have these instructions, contact your dealer for assistance.

Normally, dump trailers use the hoist battery to provide power to the breakaway brakes. If your trailer is not setup this way, there will be a small breakaway battery mounted near the breakaway switch.

Most trailers are setup to charge the battery from the tow vehicle. If the electrical system on your tow vehicle does not provide power to the battery, you must periodically charge the battery with a commercial battery charger to keep the battery charged.

### CAUTION

**Extreme cold weather can degrade battery performance and cause brakes to not operate properly.**

**Check battery charge level before towing.**

Do not tow trailer if the battery requires recharging. A discharged brake battery will not activate the brakes if the trailer uncouples from the tow vehicle. The battery must be fully charged before towing trailer.

### WARNING

**Most trailers use the hoist battery to provide power to the breakaway brakes.**

**A depleted hoist battery will not allow breakaway brakes to function if needed.**

**Hoist battery must be charged before towing trailer.**

To test the breakaway brake battery, remove the pullpin from the switch and attempt to pull the trailer forward. You should feel the trailer resisting being towed, but the wheels will not necessarily be locked. If the brakes do not function, do not tow the trailer until brakes, or battery, are repaired.

Immediately replace the pullpin. The breakaway brake battery discharges rapidly when the pullpin is removed.

## Coupling To Tow Vehicle

### WARNING

**An ineffective breakaway brake system can result in a runaway trailer, leading to death or serious injury if the receiver fails.**

**Test the function of the breakaway brake system before towing trailer. Do not tow trailer if breakaway brake system is not working; have it serviced or repaired.**

**Connect breakaway lanyard to the tow vehicle, NOT to the safety chain, ball, hitch, or support.**

Do not tow the trailer with the breakaway brake system because the brakes will overheat which can result in permanent brake failure.

### WARNING

**Failure to replace the pullpin can result in ineffective brakes, leading to loss of control, serious injury or death.**

You do not use your trailer for three or more months, during winter months:  
Store the battery indoors; and  
Charge the battery every three months.

Replace the breakaway brake battery according to the intervals specified by battery manufacturer.

### 3.1.9 UNCOUPLE TRAILER WITH BALL RECEIVER

Follow these steps to uncouple trailer from the tow vehicle:

- Park the trailer on a firm level surface and block trailer tires.
- Lower tow vehicle tailgate if equipped.
- Disconnect electrical connector.
- Disconnect breakaway brake switch lanyard.
- Disconnect safety chains from tow vehicle.
- Unlock the receiver and open it.
- Before extending jack, make certain the ground surface below the jack pad will support the tongue load.

### CAUTION

**Drop leg jacks may be spring loaded.**

**If so, they will rapidly return to the raise position when released.**

**Keep clear when releasing drop legs.**

- Lower jack drop leg if equipped.
- Rotate jack handle to extend the jack and transfer the weight of the trailer gooseneck to the jack.
- Raise the trailer receiver above the tow vehicle hitch.
- Drive tow vehicle forward.

### 4.3.2 TRAILER WITH KING PIN

A king pin connects to a fifth wheel that is installed in the bed of the tow vehicle.

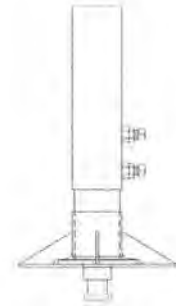

We have utilized a king pin that is suitable for the size and weight of the trailer.

You must provide a fifth wheel and support for your tow vehicle, that meets or exceeds the GVWR of the trailer.

Be sure the size and rating of the fifth wheel and kingpin match.

## Coupling To Tow Vehicle

### 4.3.2.1 BEFORE COUPLING TRAILER TO TOW VEHICLE

1. Be sure the size and rating of the fifth wheel and kingpin match.

#### **WARNING**

Receiver-to-hitch mismatch can result in uncoupling, leading to death or serious injury.

Be sure the **LOAD RATING** of the hitch ball is equal or greater than the load rating of the receiver.

Be sure the **SIZE** of the hitch ball matches the size of the receiver.

2. Check the kingpin and kingpin plate for wear, bending, cracks or corrosion before coupling. Replace worn, bent, cracked or corroded kingpin before coupling the trailer.

#### **WARNING**

A worn, cracked or corroded king pin can fail while towing, and may result in death or serious injury.

Before coupling trailer, inspect the king pin for wear, corrosion and cracks.

Replace worn or damaged king pin.

3. Wipe the kingpin clean and inspect it visually and by feel for flat spots, cracks and pits. Check the condition of the fifth wheel mounting in the bed of the tow vehicle.
4. Be sure the fifth wheel mechanism operates freely.
5. Lubricate the fifth wheel plate surface with a light coat of Lithium-base, waterproof grease.
6. Be sure the fifth wheel and kingpin fasteners are tight and any welds are solid.

#### **WARNING**

A loose fifth wheel or king pin can result in uncoupling, leading to death or serious injury.

Make sure the fifth wheel and king pin are tight before coupling the trailer.

7. Raise the bottom surface of the king pin plate to be slightly above the top of the fifth wheel.

### 4.3.2.2 PREPARE KING PIN AND FIFTH WHEEL

1. Lubricate king pin and fifth wheel with grease.
2. Lower tow vehicle tailgate if equipped.

#### **WARNING**

No one must be under the trailer or king pin during coupling.

Death or serious injury can occur if the trailer drops.

### 4.3.2.3 COUPLE TRAILER TO TOW VEHICLE

1. Back tow vehicle up close to the trailer, centering the kingpin in the slot of the fifth wheel. Stop before engaging the coupling.

#### **WARNING**

No one must be under the trailer or king pin during coupling.

Death or serious injury can occur if the trailer drops.

1. Adjust height of the trailer, using the jack, so that the king pin plate just touches the fifth wheel plate.
2. Slowly back up tow vehicle, keeping the kingpin centered in the slot of the fifth wheel. Continue backing up until the fifth wheel locks firmly on the kingpin.
3. Attempt to pull forward as an initial test of the closing of the fifth wheel locks.
4. Visually check to confirm that the fifth wheel locks are properly locked onto the kingpin.

## Coupling To Tow Vehicle

#### **CAUTION**

Drop leg jacks may be spring loaded.

If so, they will rapidly return to the raise position when released.

Keep clear when releasing drop legs.

7. Fully retract jack drop leg if equipped.
8. Raise tow vehicle tailgate if equipped.

### 4.3.2.4 CONNECT ELECTRICAL CABLE

1. Connect the trailer lights to the tow vehicle's electrical system using trailer electrical cable.
2. Check all lights for proper operation. Repair or replace non-working lights before towing trailer.
3. Check electric brakes for proper operation using brake controller mounted in the cab.

#### **WARNING**

Improper electrical connection between the tow vehicle and the trailer will result in inoperable lights and electric brakes, and can lead to collision.

Before each tow:

- Check that the electric brakes work by operating the brake controller inside the tow vehicle.

- Check that all lights and turn signals work.

### 4.3.2.5 ATTACH BREAKAWAY BRAKE LANYARD

If the king pin or fifth wheel fails, a properly connected and working breakaway brake system will apply the trailer brakes.

Connect the lanyard to the tow vehicle. Do not connect the lanyard to king pin or its support. This would keep the breakaway brake system from operating when it is needed.

Contact the hitch manufacturer or installer if you are not certain of the hitch provisions for the breakaway brake connection.

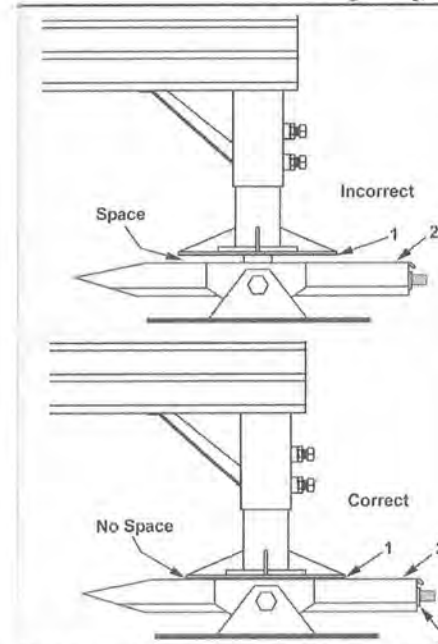

The king pin plate (1) must be in contact with the fifth wheel (2) with no space.

The adjustment nut (3) must be seated against the fifth wheel.

#### **WARNING**

An improperly coupled fifth wheel can come loose, resulting in death or serious injury.

Do not tow the trailer until all of the visual checks are met.

5. If the king pin cannot be secured to the fifth wheel, do not tow the trailer. Contact your dealer for assistance.
6. Retract the jack to its fully retracted position.



## Coupling To Tow Vehicle

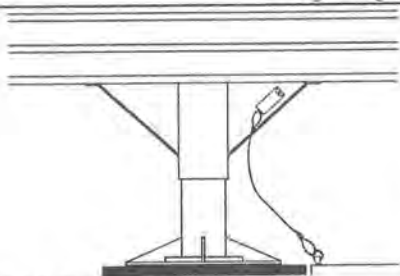

### 4.3.2.6 TEST ELECTRIC BRAKES

If your trailer has electric brakes, your tow vehicle will have an electric brake controller that sends power to the trailer brakes. Before towing the trailer on the road, you must operate the brake controller while trying to pull the trailer in order to confirm that the electric brakes operate.

While towing the trailer at less than 5 mph, manually operate the electric brake controller in the tow vehicle. You should feel the operation of the trailer brakes. If the trailer brakes are not functioning, the brake system **MUST** be evaluated to determine the cause of the problem and corrective action **MUST** be taken before the trailer is used. Take the unit to your dealer or a qualified brake specialist.

Use this procedure each time you tow the trailer to check brake system operation.

### 4.3.2.7 TEST ELECTRIC BREAKAWAY BRAKES

The breakaway brake system includes a battery, a switch with a pullpin and lanyard, and a breakaway brake controller. Read and follow the instructions here as well as the instructions that have been prepared by the breakaway brake manufacturer. If you do not have these instructions, contact your dealer for assistance.

Normally, dump trailers use the hoist battery to provide power to the breakaway brakes. If your trailer is not setup this way, there will be a small breakaway battery mounted near the breakaway switch.

Most trailers are setup to charge the battery from the tow vehicle. If the electrical system on your tow vehicle does not provide power to the battery, you must periodically charge the battery with a commercial battery charger to keep the battery charged.

### CAUTION

**Extreme cold weather can degrade battery performance and cause brakes to not operate properly.**

**Check battery charge level before towing.**

Do not tow trailer if the battery requires recharging. A discharged brake battery will not activate the brakes if the trailer uncouples from the tow vehicle. The battery must be fully charged before towing trailer.

### WARNING

**Most trailers use the hoist battery to provide power to the breakaway brakes.**

**A depleted hoist battery will not allow breakaway brakes to function if needed.**

**Hoist battery must be charged before towing trailer.**

To test the breakaway brake battery, remove the pullpin from the switch and attempt to pull the trailer forward. You should feel the trailer resisting being towed, but the wheels will not necessarily be locked. If the brake do not function, do not tow the trailer until brakes, or battery, are repaired.

Immediately replace the pullpin. The breakaway brake battery discharges rapidly when the pullpin is removed.

### WARNING

**An ineffective breakaway brake system can result in a runaway trailer, leading to death or serious injury if the king pin fails.**

**Test the function of the breakaway brake system before towing trailer. Do not tow trailer if breakaway brake system is not working; have it serviced or repaired.**

**Connect breakaway lanyard to the tow vehicle, NOT to the fifth wheel or its support.**

Do not tow the trailer with the breakaway brake system

## Coupling To Tow Vehicle

ON because the brakes will overheat which can result in permanent brake failure.

### 4.3.2.8 UNCOUPLE TRAILER WITH KING PIN

Follow these steps to uncouple trailer from the tow vehicle:

1. Park the trailer on a firm level surface and block trailer tires.
2. Lower tow vehicle tailgate if equipped.
3. Disconnect electrical connector.
4. Disconnect breakaway brake switch lanyard.
5. Before extending jack, make certain the ground surface below the jack pad will support the tongue load.

### CAUTION

**Drop leg jacks may be spring loaded.**

**If so, they will rapidly return to the raise position when released.**

**Keep clear when releasing drop legs.**

6. Lower jack drop leg if equipped.
7. Rotate jack handle to extend the jack to transfer some of the weight of the trailer to the jack.
8. Open fifth wheel lock by pulling release handle.
9. Slowly drive tow vehicle forward.
10. Raise tow vehicle tail gate if equipped.

### 4.4 TONGUE WEIGHT

It is critical to have a portion of the trailer load carried by the tow vehicle. That is, the trailer gooseneck must exert a downward force on the hitch. This is necessary for two reasons. First, the proper amount of tongue weight is necessary for the tow vehicle to be able to maintain control of the tow vehicle/trailer system. If, for example, the tongue exerts an upward pull on the hitch, instead of pushing down on it (because the trailer is overloaded behind its axle(s)), the rear wheel of the tow vehicle can lose traction or grip and cause loss of control. Also, even if there is some weight on the tongue, but not enough weight on the tongue, the trailer can become unstable at high speeds. Remember, the faster you go the more likely the trailer is to sway.

If there is too much tongue weight, the tow vehicle is prone to jack-knife. The front wheels of the tow vehicle can be too lightly loaded and cause loss of steering control.

In addition to tow vehicle control, tongue weight is necessary to insure that the trailer axle(s) do not exceed their Gross Axle Weight Rating (GAWR).

The rule of thumb is that 20-25% percentage of total weight of the trailer plus its cargo (Gross Trailer Weight, or "GTW") that should be on the tongue of the trailer.

For example, a gooseneck trailer with a loaded weight of 6,000 pounds, should have 20-25% of 6,000 pounds (1200-1500 lbs.) on the hitch.

The numbers quoted are for example purposes only and should be tailored to the specific trailer.

For questions regarding the actual percent of tongue weight for the trailer, check with the manufacturer for specifics.

### WARNING

**Improper tongue weight (load distribution) can result in loss of control of the trailer, leading to death or serious injury.**

**Make certain that tongue weight is within the allowable range.**

**Be sure to:**

- Distribute the load evenly, right and left.
- Keep the center of gravity low.
- Distribute the load front-to-rear to provide proper tongue weight.

**A flowable load must be evenly distributed throughout the body.**

### 4.5.1 CHECKING TONGUE WEIGHT

To check the tongue weight, the tow vehicle and trailer must be on level ground, as they will be when the trailer is being towed.

Take the trailer to a truck stop or grain elevator where there is a "certified" scale. Place the tow vehicle only onto the scale and get the weight. This weight must be less than your tow vehicle's GVWR.

Pull the trailer onto the scale and uncouple it from the tow vehicle, leaving just the trailer on the scale. Get a ticket which lists the total trailer weight. Re-connect the trailer to your tow vehicle and the drive the tow vehicle wheels off the scale, just leaving the trailer axles on

## Coupling To Tow Vehicle

the scale. Get a "ticket", which lists the trailer's axle weight. Simply subtract the axle weight from the total weight to determine the hitch weight.

While you are at the scale, you should weigh the entire combination vehicle. This result should be less than the Gross Combined Weight Rating (GCWR) for your towing vehicle. Some scales allow you to get individual axle weights also. If this is possible, get the tow vehicles front and rear axle weights to make sure they are in the same proportion as the tow vehicle alone, and that the rear axle is not overloaded.

### 4.5 ADJUST GOOSENECK HEIGHT

The height of the receiver or king pin on the trailer must be adjusted so that the trailer, when loaded to rated capacity, is level while connected to the tow vehicle. A level trailer allows equal weight distribution on the axles.

Your dealer or a trailer service center can perform this adjustment or you can use the following steps to adjust the hitch height yourself.

#### **WARNING**

**Improper receiver or king pin height adjustment can result in overloaded tires, blowout and loss of control, leading to death or serious injury.**

**Adjust the receiver or king pin height so that the loaded trailer is level.**

1. Connect trailer to tow vehicle and load the trailer to rated capacity. See Loading And Unloading.
2. Park the tow vehicle and trailer on a firm level surface.
3. Stand away from the trailer and visually verify if the trailer is level front-to-rear. If the front of the trailer is higher than the rear, the hitch must be raised. If the front of the trailer is lower than the rear, the hitch must be lowered.
4. Uncouple trailer from tow vehicle.
5. Loosen jam nuts and set screws (A).
6. Remove retaining pin (B) and load bearing pin (C) if equipped.
7. Extend or retract the receiver or king pin as needed up to the maximum specified by the manufacturer.
8. If equipped, fully insert load bearing pin (B) through one set of holes in coupler and outer tube. NEVER use the set screw or any other device as a replacement for the load bearing pin (B).

9. If equipped, install retaining pin (C) on load bearing pin (B).
10. Tighten setscrews (A) to the torque specified by the manufacturer.
11. Tighten jam nuts to the torque specified by the manufacturer.
12. Check tightness after 50 miles of towing.

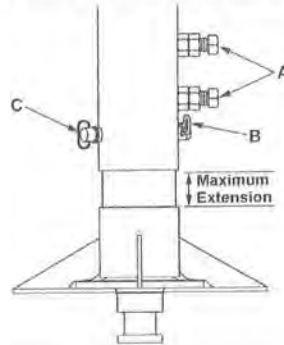

13. Couple the trailer to the tow vehicle and verify the trailer is level front to rear. Adjust if necessary.
14. Unload trailer. See Loading And Unloading.

## Loading And Unloading

### 5. LOADING AND UNLOADING

Improper trailer loading causes many accidents and deaths. To safely load a trailer, you must consider:

- Overall load weight.
- Load weight distribution.
- Proper tongue weight.
- Securing the load properly.

To determine that you have loaded the trailer within its rating, you must consider the distribution of weight, as well as the total weight of the trailer and its contents. The trailer axles carry most of the total weight of the trailer and its contents (Gross Vehicle Weight, or "GVW"). The remainder of the total weight is carried by the tow vehicle hitch.

It is essential for safe towing that the trailer tongue and tow vehicle hitch carry the proper amount of the loaded trailer weight, otherwise the trailer can develop an undesirable sway at towing speeds, or the rear of the towing vehicle can be overloaded. Read the "Tongue Weight" information in Section 4.

The load distribution must be such that no component part of the trailer is loaded beyond its rating. You must consider the rating of the tires, wheels and axles. For tandem and triple axle trailers, you must make sure that the front-to-rear load distribution does not result in overloading any axle.

Towing stability also depends on keeping the center of gravity as low as possible. Load heavy items on the floor and over the axles. When loading additional items, be sure to maintain even side-to-side weight distribution and proper tongue weight. The total weight of the trailer and its contents must never exceed the total weight rating of the trailer (Gross Vehicle Weight Rating, or "GVWR").

Do not transport people, containers of hazardous substances, or flammable liquids. The exception is fuel in the tank of vehicles or equipment being hauled.

#### **WARNING**

**Do not transport flammable, explosive, poisonous or other dangerous materials in your trailer.**

**The exception is fuel in the tank of vehicles or equipment being hauled.**

#### **WARNING**

**Do not transport people inside or on your trailer. Besides putting their lives at risk, the transport of people in or on a trailer is illegal.**

### 5.1 DUMP TRAILER HAZARDS

A dump trailer is specifically designed for hauling cargo that is to be dumped. A dump trailer is not designed for transporting livestock and/or horses. The major hazards associated with dump trailers are:

- Overloading.
- Improper weight distribution; both side to side and front to back.
- Modifying or altering dump controls.
- Not dumping from a solid and level foundation.
- Not fully opening rear doors when dumping.
- Getting under a raised dump body.
- Not using, or improperly using the body prop.
- Modifying or altering hydraulic components.
- Jerking the trailer, or hydraulics, to loosen load.
- Trailer contacting or coming near overhead power lines when body is raised.

#### **DANGER**

**NEVER alter or substitute any hydraulic system component. Death or serious injury may result.**

**An altered or component substituted hydraulic system may malfunction, resulting in the dump body falling without warning.**

**NEVER alter or substitute any hydraulic system component.**

#### **WARNING**

**A soft and/or uneven surface may cause tow vehicle and trailer to tip over when dump body is raised.**

**Raise dump body ONLY if tow vehicle and trailer are both on a firm and level surface.**

## Loading And Unloading

### WARNING

Electrocution hazard.

Dump body coming near or contacting power lines can cause electrocution.

Electrocution can occur without contact.

Verify there are no overhead power lines over or near the trailer before raising dump body.

### WARNING

An overloaded trailer or improperly distributed load can result in death or serious injury.

An overloaded trailer can cause hydraulic system to malfunction, resulting in dump body falling.

A load that is improperly distributed in the trailer can result in the trailer tipping over when the dump body is raised.

### WARNING

An overloaded trailer can result in loss of control of the trailer, leading to death or serious injury.

Do not exceed the trailer Gross Vehicle Weight Rating (GVWR) or an axle Gross Axle Weight Rating (GAWR).

Do not load a trailer so that the weight on any tire exceeds its rating.

## 5.2 LOADING FIXED LOADS

Fixed loads include palletized materials, skid-steer loaders, mowers, etc.

Fixed loads that are to be carried or dumped should be loaded evenly throughout the trailer. Too much load in the front portion will strain and possibly overload the hydraulic hoist. Too much load in the rear can lead to trailer swaying at highway speeds.

1. Couple the trailer to the tow vehicle.

### WARNING

Trailer must be coupled to tow vehicle before loading trailer.

2. Park the tow vehicle and trailer on a firm and level surface, both front-to-back and side-to-side. Attempting to load on a soft or uneven surface may cause the trailer to overturn, which can result in death or serious injury.

### WARNING

Load can suddenly move or topple, which can result in death or serious injury.

Do not load or unload trailer unless coupled to tow vehicle and is on a firm and level surface.

3. Inspect the tie down rings for any damage or cracks.
4. Clear the area around the trailer.

## 5.2.1 REAR LOADING EQUIPMENT

1. Lower rear stabilizers (if equipped) or place blocking under rear of trailer so the weight of the cargo does not raise the front of the trailer during loading.
2. Open both rear doors and secure open with door hold backs.

### CAUTION

Use a safe lifting procedure to avoid injury when handling ramps.

3. Remove ramps from storage position and place on rear of trailer. Adjust ramp position to align with equipment tires or tracks.

## NOTICE

**Ramps are not rated for load bearing capacity. They will NOT support the load bearing capacity of the trailer.**

**Do not overload ramps.**

4. Load equipment into trailer.

## Loading And Unloading

### WARNING

Trailer, hitch or dump body can fail. You or others can die or be seriously injured.

Load in the trailer must not exceed capacity and must be distributed evenly.

5. Secure the equipment to the trailer using appropriate straps, chains and tensioning devices. Refer to [www.fmcsa.dot.gov](http://www.fmcsa.dot.gov) for regulations regarding cargo securement rules.
6. Remove ramps and place in storage position.
7. Secure ramps to trailer.
8. Close, latch and pin rear doors.
9. Raise rear stabilizers (if equipped) or remove blocking under rear of trailer.

## 5.2.2 SIDE LOADING PALLETIZED MATERIAL

Trailers Equipped With Fold Down Sides Only.

### WARNING

Load can suddenly move or topple, which can result in death or serious injury.

Do not load or unload trailer unless coupled to tow vehicle and is on a firm and level surface.

1. Unlatch and open trailer side panel.
2. Materials such as pallets can now be loaded from the side of the trailer.
3. Secure the cargo to the trailer using appropriate straps, chains and tensioning devices. Refer to [www.fmcsa.dot.gov](http://www.fmcsa.dot.gov) for regulations regarding cargo securement rules.

### WARNING

Towing the trailer with side panel lowered creates a driving hazard, which may result in death or serious injury.

Both side panels must be raised and locked before towing trailer.

4. Raise and lock side panels before towing trailer.

## 5.3 LOADING AND UNLOADING BULK MATERIAL

Check if the trailer has "payload" decals. If not, then determine the payload, or cargo capacity, by subtracting the empty weight of the trailer from the GVWR given on the Certification / VIN tag. Determine the density of the material to be loaded and dumped so that you will know, approximately, the amount of material may be safely loaded, carried, and dumped.

## 5.3.1 PREPARE TRAILER FOR LOADING

1. Couple the trailer to the tow vehicle.

### WARNING

Trailer must be coupled to tow vehicle before loading trailer.

2. Park the tow vehicle and trailer on a firm and level surface, both front-to-back and side-to-side. Attempting to load on a soft or uneven surface may cause the trailer to overturn, which can result in death or serious injury.

### WARNING

Load can suddenly move or topple, which can result in death or serious injury.

Do not load or unload trailer unless coupled to tow vehicle and is on a firm and level surface.

3. Clear the area around the trailer.
4. Close and latch trailer doors.

### WARNING

Unsecured rear doors can cause a driving hazard.

Do not operate trailer without properly securing rear door latches.

## 5.3.2 LOADING BULK MATERIAL

1. Tell the loader operator the payload of your trailer. The loader operator will have an approximate weight of the material to be loaded.
2. Use common sense when loading. If you are uncertain of the weight of the material, load a small amount and weigh your trailer. It is much easier to

## Loading And Unloading

add to a light load than to remove material from an overloaded trailer.

- Level (evenly distribute) the load within the trailer from front to back and from side to side.
- If material may blow out while driving, tarp the trailer.
- If the trailer is overloaded, DO NOT attempt to raise the dump body. The excess material must be removed by equipment designed for this purpose, or by hand.

### 5.3.3 UNLOAD BULK MATERIAL WITH SPREADER GATE

- Read and understand the hoist operating procedure before operating the dump body.
- Clear the area around the dump trailer.
- Park the tow vehicle and trailer on a firm and level surface both side-to-side and front-to-rear. Attempting to unload on a soft or uneven surface may cause the trailer to overturn, which can result in death or serious injury. Trailer must be coupled to tow vehicle.
- For spreading material, the surface in which the tow vehicle and trailer will travel MUST be firm and level.

#### WARNING

A soft and/or uneven surface may cause the tow vehicle and trailer to overturn when the dump body is raised or while spreading material.

Raise the dump body ONLY if the tow vehicle and trailer are both on a firm and level surface.

#### WARNING

An overloaded trailer or improperly distributed load can result in death or serious injury.

An overloaded trailer can cause hydraulic system to malfunction, resulting in dump body falling.

A load that is improperly distributed in the trailer can result in the trailer tipping over when the dump body is raised.

#### WARNING

**Raised dump body can drop or tip over suddenly. You and others can die or be seriously injured.**

**You must:**

- Have trailer on level, firm ground before dumping.
- Keep others away while dumping.
- Stay at controls until dump body is down. NEVER LEAVE THE SCENE WHEN DUMP BODY IS LIFTED.
- Lock hoist controls after use.
- Have dump body down before moving trailer.
- Use body prop and have dump body empty before getting under raised dump body.

If the hoist does not lift the load, manually reduce the load - obtain service from a qualified hydraulics technician. NEVER ASSIST THE HOIST. (i.e., with a jack, crane, heavy equipment, etc.)

If the load does not leave the dump body, lower the dump body and manually free the load.

Never attempt to free a load from a raised dump body.

- Set the metering chains at the desired number of links to control the opening distance of the spreader gate. Be sure to set both chains at equal length.
- Unlock spreader gate.

#### WARNING

**Loaded materials can exert pressure against the spreader gate.**

This may cause the spreader gate to swing out with force when unlocked, causing serious injury.

Stand on the side of the trailer to unlock spreader gate.

## Loading And Unloading

Open the battery box and support lid with prop rod.

Locate the dump body controller. While using the dump body controller, position yourself in a safe location clear of the dump body. Check for overhead power lines and other obstructions before raising dump body.

#### DANGER

**A lowering or falling dump body can result in death or serious injury.**

**NEVER enter the area under the dump body unless the empty dump body is supported by the body prop.**

#### DANGER

**The body prop is designed to support an empty dump body only.**

**NEVER support a loaded dump body by the body prop.**

**Unload the dump body before using body prop.**

#### WARNING

Electrocution hazard.

Dump body coming near or contacting power lines can cause electrocution.

Electrocution can occur without contact.

Verify there are no overhead power lines over or near the trailer before raising dump body.

Press and hold button to raise the dump body. Release the button when the body has reached approximately the halfway point of its dumping angle, or if the load begins to shift rearward. Never leave the dump body control when operating the dump body.

#### WARNING

**Fully raising the loaded dump body may result in the tow vehicle rear wheels losing traction.**

**Do not fully raise a loaded dump body or place the entire load at the rear of trailer.**

- Return the dump body control to the battery box. Watch for and avoid obstructions such as tree limbs, overhead lines, potholes, etc. and SLOWLY drive the tow vehicle and trailer ahead to spread the material.
- DO NOT drive forward and stop quickly to "shock" the load out of the body. DO NOT "jerk" the control button up and down to dislodge the load. The proper procedure for a stuck load is to fully lower the dump body and dislodge the material by hand.
- You may need to raise the dump body higher after a portion of the load has been spread to place the remaining material at the rear of the dump body.
- Stop tow vehicle after all material has exited the dump body.
- Press and hold button to lower the dump body. Release the button when the dump body is fully lowered. Place dump body controller in the storage or travel location. Close and lock battery box.

#### NOTICE

*Prevent trailer damage.*

*Trailers equipped with a power down hydraulic system can be damaged if the down button is held after the dump body is fully lowered.*

*Release down button when the dump body is fully lowered.*

#### WARNING

**Risk of battery exploding.**

**Battery box prop rod may contact battery terminals, which may result in the battery exploding.**

**Place battery box lid prop rod in retaining clip.**

## Loading And Unloading

**Gooseneck Mounted Battery Boxes Only:** When closing the battery box lid, place the prop rod in the retaining clip on the side of the battery box.

Failure to do so may result in the prop rod contacting the battery terminals, which can result in the battery exploding.

15. Close and latch rear gates before moving trailer.

### WARNING

Unsecured rear gates can cause a driving hazard.

Do not operate trailer without properly securing rear gate latches.

### 5.3.4 UNLOAD BULK MATERIAL WITH SWING GATES

1. Read and understand the hoist operating procedure before operating the dump body.
2. Clear the area around the dump trailer.
3. Park the tow vehicle and trailer on a firm and level surface both side-to-side and front-to-rear. Attempting to unload on a soft or uneven surface may cause the trailer to overturn, which can result in death or serious injury. Trailer must be coupled to tow vehicle.

### WARNING

A soft and/or uneven surface may cause the tow vehicle and trailer to overturn when the dump body is raised or while spreading material.

Raise the dump body ONLY if the tow vehicle and trailer are both on a firm and level surface.

### WARNING

Loaded materials can exert pressure against the swing gates. This may cause the gates to swing out with force when unlatched, causing serious injury.

Stand away from the trailer to unlock swing gates.

### WARNING

An overloaded trailer or improperly distributed load can result in death or serious injury.

An overloaded trailer can cause hydraulic system to malfunction, resulting in dump body falling.

A load that is improperly distributed in the trailer can result in the trailer tipping over when the dump body is raised.

4. Open both rear doors and lock open with door hold backs.
5. Open the battery box and support lid with prop rod.
6. Locate the dump body controller. While using the dump body controller, position yourself in a safe location clear of the dump body. Check for overhead power lines and other obstructions before raising dump body.

### DANGER

A lowering or falling dump body can result in death or serious injury.

NEVER enter the area under the dump body unless the empty dump body is supported by the body prop.

### DANGER

The body prop is designed to support an empty dump body only.

NEVER support a loaded dump body by the body prop.

Unload the dump body before using body prop.

## Loading And Unloading

### WARNING

Electrocution hazard.

Dump body coming near or contacting power lines can cause electrocution.

Electrocution can occur without contact.

Verify there are no overhead power lines over or near the trailer before raising dump body.

7. Press and hold button to raise the dump body. Release the button when the body has reached approximately the halfway point of its dumping angle, or if the load begins to shift rearward. Never leave the dump body control when operating the dump body.

### WARNING

Fully raising the loaded dump body may result in the tow vehicle rear wheels losing traction.

Do not fully raise a loaded dump body or place the entire load at the rear of trailer.

8. Discontinue pushing the up button and walk to the rear of the trailer so you can estimate if there is enough space for the remainder of the load to be safely dumped. If not, then you need to fully lower the dump body by pushing and holding the down button and then pull the trailer forward and then repeat step 7.
9. Standing well clear of the dump body, raise the dump body to the three quarter point of the maximum dump angle. Discontinue pushing the up button and walk to the rear of trailer to check to see if there is enough space for continued dumping.
10. Repeat the process until the load has been completely dumped.
11. If the load has not completely dumped DO NOT drive forward and stop quickly to "shock" the load out of the body. DO NOT "jerk" the control button up and down to dislodge the load. The proper procedure for a stuck load is to lower the dump and dislodge the material by hand.
12. Press and hold the down button to lower the dump body.
13. Release the button when the dump body is fully

lowered. Place dump body control in the battery box. Close and lock battery box.

### NOTICE

*Prevent trailer damage.*

*Trailers equipped with a power down hydraulic system can be damaged if the down button is held after the dump body is fully lowered.*

*Release down button when the dump body is fully lowered.*

### WARNING

Risk of battery exploding.

Battery box prop rod may contact battery terminals, which may result in the battery exploding.

Place battery box lid prop rod in retaining clip.

**Gooseneck Mounted Battery Boxes Only:** When closing the battery box lid, place the prop rod in the retaining clip on the side of the battery box.

Failure to do so may result in the prop rod contacting the battery terminals, which can result in the battery exploding.

14. Close and latch rear gates before moving trailer.

### WARNING

Unsecured gate(s) can cause a driving hazard.

Do not operate trailer without properly securing rear gate latches.

### 5.4 HYDRAULIC COMPONENTS

Do not alter or substitute and hydraulic components on the dump trailer. The hydraulic system is designed with each component being compatible with the safe and reliable operation of the hydraulic system. **Under no circumstances should you alter the hydraulic pressure or flow rate in the hydraulic system.**

## Loading And Unloading

### DANGER

Crushing hazard.

An altered or component substituted hydraulic system may malfunction, resulting in the dump body falling without warning.

NEVER alter or substitute any hydraulic system component.

Always have the hydraulic system repaired or maintained by a qualified technician.

### 5.5 BODY PROP

The body prop supplied as part of the trailer is to be used only when the dump body is empty. The purpose of the body prop is a back-up to the hydraulic system and will hold the empty dump body in a raised position while performing maintenance on the hoist, trailer body, or the trailer itself.

Body prop may be located at front of prop dump body or at side of dump body.

Note: For service or technical questions on the hydraulic pump, refer to the hydraulic manual specifications. Contact the pump manufacturer for additional questions or pump warranty issues.

DO NOT use the body prop to support a loaded dump body.

DO NOT enter the area under a raised dump body without first supporting the empty dump body up with the body prop.

### DANGER

Risk of death by crushing.

Empty dump body before using body prop.

### WARNING

Crushing hazard.

DO NOT manipulate the body prop if a person is near the operating control.

### WARNING

Crushing hazard.

Dump body can drop unexpectedly.

Never go under a raised dump body.

Use body prop for maintenance.

Park the trailer on a firm and level surface. Raise the dump body and place the body prop in the upright position. Lower the dump body onto the body prop. The body prop must engage the body prop receiver.

### NOTICE

Prevent trailer damage.

Trailers equipped with a power down hydraulic system can be damaged if the down button is held after the dump body is lowered onto the body prop.

Release the down button when the dump body is lowered onto the body prop.

### WARNING

Risk of battery exploding.

Battery box prop rod may contact battery terminals, which may result in the battery exploding.

Place battery box lid prop rod in retaining clip.

Gooseneck Mounted Battery Boxes Only: When closing the battery box lid, place the prop rod in the retaining clip on the side of the battery box.

Failure to do so may result in the prop rod contacting the battery terminals, which can result in the battery exploding.

## Pre-Tow Checklist

### 6 SECURING CARGO

Since the trailer cargo is subjected to longitudinal (front/back) and lateral (side / side) forces you must secure cargo that is not flowable, so that it does not shift while the trailer is being towed.

### WARNING

Shifting cargo can result loss of control of the trailer, and can lead to death or serious injury.

Secure down all loads with proper sized tensioners, chains, straps, etc.

Refer to [www.fmcsa.dot.gov](http://www.fmcsa.dot.gov) for regulations regarding cargo securement rules.

### 6. PRE-TOW CHECKLIST

#### 6.1 PRE-TOW CHECKLIST

Before towing, double-check all of these items:

- Tires, wheels and lug nuts. See "Breaking In A New Trailer" section of this manual.
- Tire Pressure. Inflate tires on trailer and tow vehicle to the pressure stated on the Certification / VIN label.
- Receiver secured and locked. See "Coupling To Tow Vehicle" section of this manual.
- Safety chains properly rigged to tow vehicle, not to hitch or ball. See "Coupling To Tow Vehicle" section of this manual.
- Test Tail, Stop, and Turn Lights.
- Test trailer brakes.
- Safety breakaway lanyard fastened to tow vehicle, not to safety chains. See "Coupling To Tow Vehicle" section of this manual.
- Cargo properly loaded, balanced and tied down. See the appropriate "Loading And Unloading" section of this manual.
- Tongue weight and weight distribution set-up.
- Ramps secured for travel.
- Fire extinguisher.
- Flares and reflectors.

#### 6.2 MAKE REGULAR STOPS

After each 50 miles, or one hour of towing, stop and check the following items:

- Receiver secured.
- Safety chains are fastened and not dragging.
- Cargo secured.
- Doors latched and secured.

## 7. BREAKING IN A NEW TRAILER

### 7.1 RETIGHTEN LUGS AT FIRST 10, 25 & 50 MILES

Wheel lugs can shift and settle quickly after being first assembled, and must be checked after the first 10, 25 and 50 miles of driving. Failure to perform this check may result in a wheel coming loose from the trailer, causing a crash leading to death or serious injury. Improper tightening of the lug nuts or bolts voids the axle warranty.

Refer to the Inspection, Service and Maintenance section of this manual.

#### WARNING

Lug nuts or bolts are prone to loosen after being first assembled. Death or serious injury can result.

Check lug nuts or bolts for tightness on a new trailer, and after re-mounting a wheel at 10, 25 and 50 miles.

### 7.2 ADJUST BRAKES AT FIRST 200 MILES

Brake shoes and drums experience a rapid initial wear. The brakes must be adjusted after the first 200 miles of use, and each 3,000 miles thereafter. Some axles are fitted with a mechanism that will automatically adjust the brake shoes.

Read your axle and brake manual to see if your brakes adjust automatically. If you do not have the axle and brake manual, contact your dealer for assistance.

If your trailer is not fitted with automatically adjusting brakes, the brakes will need to be manually adjusted. See section 9 for instructions.

### 7.3 SYNCHRONIZING BRAKE SYSTEMS

Trailer brakes are designed to work in synchronization with the brakes on the tow vehicle. When the tow vehicle and trailer braking systems are synchronized, both braking systems contribute to slowing, and the tongue of the trailer will neither dive nor rise sharply.

#### WARNING

If trailer and tow vehicle brakes do not work properly together, death or serious injury can occur.

Road test the brakes in a safe area at no more than 30 m.p.h. before each tow.

To insure safe brake performance and synchronization, read and follow the axle/brake and the brake controller manufacturers' instructions. If you do not have these instructions, contact your dealer for assistance.

## 8. ACCESSORIES

This chapter provides some basic information for the safe operation of accessories.

You must read and follow these instructions before using the accessory. If you are uncertain whether you have all of the instructions, contact your dealer before operating the accessory.

### 8.1 ACCESSORY BATTERY

Your trailer is equipped with an accessory battery that operates the dump body.

The battery may be kept charged either by the tow vehicle, by an auxiliary charger or by using an on-board battery maintainer/charger (if equipped). If the trailer is used daily, it is recommended that the battery charger be plugged in after each days use. The battery may be located in a tongue mounted battery box or a side mounted box.

The accessory battery must be kept in a charged condition during storage. The battery could freeze and break if it becomes discharged.

If the battery is not fully charged, the hydraulic pump will lose pressure which may cause hydraulic fluid to flow back into the hydraulic reservoir, overfilling the reservoir and ejecting fluid into the battery box.

#### WARNING

Risk of battery exploding.

Battery box prop rod may contact battery terminals, which may result in the battery exploding.

Place battery box lid prop rod in retaining clip.

**Gooseneck Mounted Battery Boxes Only:** When closing the battery box lid, place the prop rod in the retaining clip on the side of the battery box.

Failure to do so may result in the prop rod contacting the battery terminals, which can result in the battery exploding.

## Inspection, Service And Maintenance

### 9. INSPECTION, SERVICE AND MAINTENANCE

#### 9.1 INSPECTION, SERVICE & MAINTENANCE SUMMARY CHARTS

You must inspect, maintain and service your trailer regularly to insure safe and reliable operation. If you cannot or are unsure how to perform the items listed here, have your dealer do them. Note: In addition to this manual, also check the relevant component manufacturer's manual.

Inspection And Service Before Each Tow		
Item	Inspection/Service	Manual Section Reference
Breakaway Brakes		
• Electric	Check operation.	Section 4.
• Hydraulic	Check operation.	Section 4.
Breakaway Battery	Fully charged, connections clean	Section 4 and 9.
Brakes		
• Electric	Check operation.	Section 4 and 9.
• Hydraulic	Check operation. Check reservoir level	
Shoes And Drums	Adjust	Section 9.
Safety Chains And Hooks	Check for wear, damage.	Section 4.
Receiver And Hitch Ball	Check for cracks, pits, and flats. Replace w/ ball and receiver having trailer GVW Rating.	Section 4 and 9.
	Grease.	Section 4 and 9.
	Check locking device & replace when worn.	Section 4 and 9.
King Pin And Fifth Wheel	Check for cracks, pits, and flats. Replace w/ king pin and fifth wheel having trailer GVW Rating.	Section 4 and 9.
	Grease.	Section 4 and 9.
	Check locking device & replace when worn.	Section 4 and 9.
Tires	Check tire pressure when cold. Inflate as needed.	Section 6 and 9
	Check for damage.	Section 6 and 9
Wheels - Lug Nuts Or Bolts & Hub	Check for tightness.	Section 6.
	Tighten. For new and remounted wheels, check torque after first 10, 25 & 50 miles of driving and after any impact.	Section 7 and 9.

## Inspection, Service And Maintenance

Inspection And Service Every Month		
Item	Inspection / Service	Manual Section Reference
Lubrication	Lubricate door hinges and dump body pivots.	Section 9.
Inspection and Service Every 6 Months or 6,000 Miles		
Item	Inspection/Service	Manual Section Reference
Brakes, electric		
• Magnet	Check wear and current draw.	Section 9.
• Controller (in tow vehicle)	Check power output (amperage) and modulation.	Section 9. See Controller Mfr's Manual
Tires	Inspect tread and sidewalls thoroughly.	Section 9.
	Replace tire when treads are worn, when sidewall has a bulge, or sidewall is worn.	Section 9.
	Rotate every 5,000 Miles.	Section 9.
Brakes		
• Electric	Check Operation.	Section 4 and 9.
• Hydraulic	Check Operation. Check Reservoir Level.	
Brake Shoes And Drums	Adjust	Section 7 and 9.
Safety Chains & Hooks	Check for wear, damage.	Section 4.
Receiver And Hitch Ball	Check for cracks, pits, and flats. Replace w/ ball and receiver having trailer GVW Rating.	Section 4 and 9.
	Grease.	Section 4 and 9.
	Check locking device & replace when worn.	Section 4 and 9.
King Pin And Fifth Wheel	Check for cracks, pits, and flats. Replace w/ king pin and fifth wheel having trailer GVW Rating.	Section 4 and 9.
	Grease.	Section 4 and 9.
	Check locking device & replace when worn.	Section 4 and 9.



## Inspection, Service And Maintenance

Inspection And Service Every Year or 12,000 Miles		
Item	Inspection/Service	Manual Section Reference
Brakes, all types • Shoes and Drums	Check for scoring and wear. Replace per manufacturer's specifications.	Section 9.  See Brake Mfr's Manual
Jack, Drop-leg (if equipped)	Grease gears at top.	See Jack Mfr's Manual
Structure • Frame Members	Inspect all frame members, bolts & rivets. Repair or replace damaged, worn or broken parts.	Section 9.
• Welds	Inspect all welds. Repair as needed.	Section 9.
Wheels • Wheel Bearings	Disassemble / inspect / assemble and repack. Replace promptly if immersed in water.	Section 9 & See Axle Mfr's Manual
• Rims	Inspect for cracks & dents. Replace as needed.	
Structure • Axle Attachment Bolts	Check BY DEALER	Section 9.

## Inspection, Service And Maintenance

### 9.2 INSPECTION AND SERVICE INSTRUCTIONS

#### WARNING

**Worn or broken suspension parts can cause loss of control and injury may result.**

**Have trailer professionally inspected annually and after any impact.**

To perform many of the inspection and maintenance activities, you must jack up the trailer.

When jacking and using jack stands, place them so as to clear wiring, brake lines, and suspension parts (springs, torsion bars, etc.). Place jacks and jack stands under the outer frame rail to which the axles are attached.

#### WARNING

**Never go under trailer unless it is on firm and level ground and resting on properly placed and secured jack stands.**

#### WARNING

**Crushing hazard.**

**The tow vehicle and trailer could be inadvertently moved while a person is under the trailer.**

**The tow vehicle engine must be off, ignition key removed and parking brakes set before entering the area under the trailer.**

#### 9.2.1 TRAILER STRUCTURE

Wash the trailer as needed with a power washer and a detergent solution.

##### 9.2.1.1 FASTENERS AND FRAME MEMBERS

Inspect all fasteners and structural frame members for bending and other damage, cracks, or failure. Repair or replace any damaged fastener and repair the frame member. If you have any questions about the condition or method of repair of fasteners or frame members, get the recommendation of, or have the repair done by your dealer.

#### WARNING

**Broken or damaged fasteners can cause injury or damage to trailer and contents.**

**Inspect for, and repair all damaged parts at least once a year.**

##### 9.2.1.2 WELDS

All welds can crack or fail when subjected to heavy loads or movement of cargo that was not properly secured. Any time that you know or suspect that the trailer has been subjected to heavy loads or movement of cargo, immediately inspect the welds and fasteners for damage. To prevent severe damage to your trailer, inspect all of the welds for cracks or failure at least once a year. If a weld failure is detected, contact your dealer.

#### WARNING

**Do not attempt to repair a cracked or broken weld unless you have the skills and equipment to make the repair.**

**Improper weld repair will lead to early failure of the trailer structure and serious injury or death.**

**See your dealer for weld repairs.**

#### WARNING

**Broken or damaged welds can cause injury or damage to trailer and contents.**

**Inspect for, and repair all damaged parts at least once a year.**

#### 9.2.2 TRAILER BRAKES - ELECTRIC

##### 9.2.2.1 BRAKE DISCS, SHOES AND DRUMS

Properly functioning brake shoes and drums are essential to ensure safety. You must have your dealer inspect these components at least once per year, or each 12,000 miles. Brake adjustment is not covered under the axle warranty.

The brake shoes must be adjusted after the first 200 miles of use, and each 3,000 miles thereafter. Most axles are fitted with a brake mechanism that will automatically adjust the brake shoes when the trailer

## Inspection, Service And Maintenance

is "hard braked" from a rearward direction. Trailer disc brakes are self-adjusting and do not need to be periodically adjusted. Using pads or shoes without enough brake lining material can result in brake damage, create excessive heat and potentially cause the loss of braking capacity. Read your axle and brake manual to see how to adjust your brakes. If you do not have this manual, contact your dealer for assistance.

### 9.2.2.2 MANUALLY ADJUSTING BRAKE SHOES

Some braking systems are not automatically adjusted. These brakes require manual adjustment. The following steps apply to adjust most manually adjustable brakes.

Read your axle and brake manual to see how to adjust your brakes. If you do not have this manual, contact your dealer for assistance.

1. Jack up the trailer and secure it on adequate capacity jack stands.
2. Be sure the wheel and brake drum rotate freely.
3. Remove the adjusting-hole cover from the adjusting slot on the bottom of the brake backing plate.
4. With a screwdriver or standard adjusting tool, rotate the starwheel of the adjuster assembly to expand the brake shoes. Adjust the brake shoes out until the pressure of the linings against the drum makes the wheel very difficult to turn. Note: Your trailer maybe equipped with drop spindle axles. See axle manual for your axle type. You will need a modified adjusting tool for adjusting the brakes in these axles.
5. Rotate the starwheel in the opposite direction until the wheel turns freely with a slight drag.
6. Replace the adjusting-hole cover.
7. Repeat the above procedure on all brakes.
8. Lower the trailer to the ground.

### 9.2.2.3 ELECTRIC BRAKES

Two different types of electric brakes may be present on the trailer: an emergency electric breakaway system, which acts only if the trailer comes loose from the hitch and the breakaway pin is pulled. The other brake is an electric braking system that acts whenever the brakes of the tow vehicle are applied.

**Breakaway Battery** - This battery supplies the power to operate the trailer brakes if the trailer uncouples from the tow vehicle. Be sure to check, maintain and replace the battery according to the battery manufacturer's instructions. Your trailer may use the hydraulic system

battery to operate the breakaway brakes.

#### CAUTION

Extreme cold weather can degrade battery performance and cause brakes to not operate properly.

Check battery charge level before towing.

**Breakaway Switch** - This switch engages the electric brakes if the trailer uncouples from the tow vehicle. To check for proper functioning of the switch, battery and brakes, you must pull the pin from the switch and confirm that the brakes apply to each wheel. You can do this by trying to pull the trailer with the tow vehicle, after pulling the pin. The trailer brakes may not lock, but you will notice that a greater force is needed to pull the trailer.

#### WARNING

If electric breakaway brakes do not operate when trailer is uncoupled from the tow vehicle, death or serious injury can occur.

Check emergency breakaway brake system before each tow.

### 9.2.2.4 TOW VEHICLE OPERATED ELECTRIC BRAKES

The electric brakes that operate in conjunction with the tow vehicle brakes must be "synchronized" so that braking is properly distributed to the tow vehicle brakes and the trailer brakes. For proper operation and synchronization, read and follow the axle/brake and the brake controller manufacturers' instructions. If you do not have these instructions, contact your dealer for assistance.

### 9.2.2.5 ELECTRIC BRAKE MAGNETS

To make certain an electrically-operated braking system will function properly, you must have your dealer inspect the magnets at least once a year, or each 12,000 miles. See the brake manual for wear and current inspection instructions.

### 9.2.3 TRAILER BRAKES - HYDRAULIC (IF EQUIPPED)

Check reservoir fluid level prior to using the trailer.

## Inspection, Service And Maintenance

Check with your dealer for the type of fluid used in the brake system.

#### WARNING

Use only fresh fluid from a sealed container. DO NOT reuse fluid. After filling and bleeding, refill the actuator.

Failure to maintain an adequate fluid level may cause brake failure.

### 9.2.4 TRAILER CONNECTION TO TOW VEHICLE

#### 9.2.4.1 GOOSENECK RECEIVER AND BALL

Before each tow, coat the ball with a thin layer of automotive bearing grease to reduce wear and ensure proper operation; and check the locking device that secures the receiver to the ball for proper operation.

If you see or can feel evidence of wear, such as flat spots, pitting or corrosion, on the ball or receiver, immediately have your dealer inspect them to determine the proper action to prevent possible failure of the ball and receiver system.

When replacing a ball, the load rating must match or exceed the GVWR of the trailer.

#### 9.2.4.2 KING PIN AND FIFTH WHEEL

Before each tow, inspect the fifth wheel and kingpin for wear, and coat the contact surface of the fifth wheel plate with water-resistant Lithium-base grease.

If you see evidence of wear on the fifth wheel or kingpin, immediately have your dealer inspect them to determine the proper action to prevent failure of the fifth wheel and kingpin system.

When replacing a king pin and fifth wheel, the load rating must match or exceed the GVWR of the trailer.

### 9.2.5 LANDING LEG OR JACK

If a grease fitting is present, use a grease gun to lubricate the jack mechanism. Grease the gears in the flap of hand-cranked jacks once a year, by removing the top of the jack and pumping or hand packing grease into the gears.

### 9.2.6 LIGHTS AND SIGNALS

Before each tow, check all trailer lights for proper

operation.

#### WARNING

To avoid risk of collisions, all lights must work.

### 9.2.7 WHEEL RIMS

If the trailer has been struck, or impacted, on or near the wheels, or if the trailer has struck a curb, inspect the rims for damage. Replace any damaged wheel. Inspect the wheels for damage every year, even if no obvious impact has occurred.

### 9.2.8 WHEEL BEARINGS

A loose, worn or damaged wheel bearing is the most common cause of brakes that grab.

To check your bearings, jack up the trailer and secure it on adequate capacity jack stands. Check wheels for side-to-side looseness.

If the wheels are loose, or spin with a wobble, the bearings must be serviced or replaced.

#### WARNING

Never go under trailer unless it is on firm and level ground and resting on properly placed and secured jack stands.

If your axle(s) are equipped with a grease zerk on the ends of the axle(s), the bearings must be greased every 6 months or 6,000 miles to ensure reliable and safe operation of your trailer.

1. Remove the rubber plug from the axle end.
2. Place grease gun on zerk.
3. Pump grease until new grease begins to appear. Use a different color grease each time so you will know when the new grease begins to appear.
4. Install rubber plug and cap. Repeat for remaining wheel bearings.

If your trailer axle(s) are not equipped with grease zerks, refer to the axle manufacturer's manual for service and maintenance information.

### 9.2.9 TIRES

Before each tow, check the tire pressure to make sure it is at the level indicated on the tire sidewall or VIN label. Tire pressure must be checked while the tire





## Inspection, Service And Maintenance

is cold. Do not check tire pressure immediately after towing the trailer. Allow at least three hours for the tires to cool, if the trailer has been towed for as much as one mile. Tires can lose air over a period of time

Replace the tire before towing the trailer if the tire treads have less than 2/32 inch depth or the telltale bands are visible.

A bubble, cut or bulge in a side wall can result in a tire blowout. Inspect both side walls of each tire for any bubble, cut or bulge; and replace a damaged tire before towing the trailer.

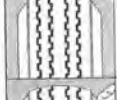
If you are storing your trailer for an extended period, make sure the tires are inflated to the maximum rated pressure indicated on the sidewall or VIN label and that you store them in a cool, dry place such as a garage. Use tire covers to protect the tires from the harsh effects of the sun.

	Condition	Possible Cause	Remedy
	Even Center Wear	Over Inflation	Check & Adjust Pressure When Cold
	Inside & Outside Wear	Under Inflation	Check & Adjust Pressure When Cold
	Smooth, Side Wear - One Side	Loss of Camber or Overloading	Check & Unload As Necessary. Have Alignment Checked
	"Feathering" Across The Face	Axle Not Square To Frame or Incorrect Toe In	Square Axles. Have Alignment Checked
	Cupping	Loose Bearings or Wheel Balance	Check Bearing Adjustment and Wheel & Tire Balance
	Flat Spots	Wheel Lockup	Adjust Brakes

Tire Inspection Chart

**WARNING**

**Worn, damaged or under-inflated tires can cause loss of control, injury and damage.**

**Check tires before each tow.**

### 9.2.10 LUBRICATION

**WARNING**

**Crushing hazard.**

**Dump body can drop unexpectedly.**

**Never go under a raised dump body.**

**Empty dump body before using body prop.**

**Use body prop for maintenance.**

**DO NOT manipulate the body safety prop if a person is near the control.**

The body prop supplied as part of the trailer is to be used only when the dump body is empty. The purpose of the body prop is a back-up to the hydraulic system and will hold the empty dump body in a raised position while performing maintenance on the hoist, trailer body, or the trailer itself.

DO NOT use the body prop to support a loaded dump body.

DO NOT go under a raised dump body unless the dump body is supported by the body prop.

1. Park the trailer on a firm and level surface.
2. Pump grease into the dump body hinge fittings and rear door hinges every month.
3. Raise the dump body and place the body prop in the upright position. Lower the dump body onto the body prop. The body prop must engage the receiver.
4. Pump grease into the fittings on each end of the cylinder(s) and in the scissor mechanism (if equipped). The number of grease fittings and location on the scissor mechanism will vary by trailer model.
5. For trailers equipped with fold down sides, pump grease into each fitting on the fold down side hinges every month.

## Inspection, Service And Maintenance

as paint or grease, which may result in inaccurate torque readings. Over-tightening will result in breaking the studs or permanently deforming the mounting stud holes in the wheels, and will void the axle warranty.

### 9.2.11 HYDRAULIC RESERVOIR

Check fluid level prior to using the trailer. The reservoir is normally located inside the battery box.

The dump body must be fully lowered before checking fluid level. The reservoir should be filled to the full mark on the side of the reservoir.

Use a quality hydraulic fluid with anti-wear properties, rust and oxidation inhibitors. Fluid ejecting from the reservoir could indicate a low battery.

### 9.2.12 Lug Nuts

Lug nuts are prone to loosen right after a wheel is mounted to a hub. When driving on a remounted wheel, check to see if the lug nuts are tight after the first 10, 25 and 50 miles of driving, and before each tow thereafter.

**WARNING**

**Lug nuts or bolts are prone to loosen after being first assembled. Death or serious injury can result.**

**Check lug nuts or bolts for tightness on a new trailer, and after re-mounting a wheel at 10, 25 and 50 miles.**

**WARNING**

**Metal creep between the wheel rim and lug nuts or bolts can cause rim to loosen.**

**Death or injury can occur if wheel comes off.**

**Tighten lug nuts or bolts before each tow.**

Tighten the lug nuts or bolts in three stages to the final torque for the axle size on your trailer, to prevent wheels from coming loose. Tighten each lug nut or bolt in the order shown in the following figure.

Use a calibrated torque wrench to tighten the fasteners. Verify that wheel studs are free of contaminants such

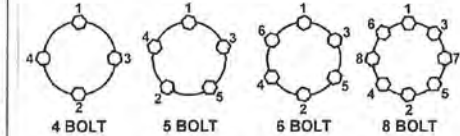

See your axle manufacturers manual or your dealer for wheel nut or bolt torque specifications.